

Contract for the sale and purchase of land 2022 edition

TERM	MEANING OF TERM	eCOS ID: 107902033	NSW DAN:
vendor's agent	Upstate Real Estate Level 1, Suite 15/888 Pittwater Rd, Dee Why NSW 2099		Phone: (02) 9971 9000 Fax:
co-agent			Ref: Chris Aldren
vendor	SI XIN YUAN		
vendor's solicitor	Linc at Law Suite 3 Level 9 99 York Street SYDNEY NSW 2000		Phone: 02 9299 7768 Fax: 02 8088 7355
date for completion	42 days after the contract date	(clause 15)	Email: info@lincatlaw.com.au
land	G12/23 PACIFIC PDE DEE WHY NSW 2099 (Address, plan details and title reference) LOT 12 IN STRATA PLAN 95882 12/SP95882		
	<input type="checkbox"/> VACANT POSSESSION	<input type="checkbox"/> Subject to existing tenancies	
improvements	<input type="checkbox"/> HOUSE <input type="checkbox"/> garage <input type="checkbox"/> carport <input type="checkbox"/> home unit <input type="checkbox"/> carspace <input type="checkbox"/> storage space <input type="checkbox"/> none <input type="checkbox"/> other:		
attached copies	<input type="checkbox"/> documents in the List of Documents as marked or as numbered: <input type="checkbox"/> other documents:		

A real estate agent is permitted by legislation to fill up the items in this box in a sale of residential property.

inclusions	<input type="checkbox"/> air conditioning	<input type="checkbox"/> clothes line	<input type="checkbox"/> fixed floor coverings	<input type="checkbox"/> range hood
	<input type="checkbox"/> blinds	<input type="checkbox"/> curtains	<input type="checkbox"/> insect screens	<input type="checkbox"/> solar panels
	<input type="checkbox"/> built-in wardrobes	<input type="checkbox"/> dishwasher	<input type="checkbox"/> light fittings	<input type="checkbox"/> stove
	<input type="checkbox"/> ceiling fans	<input type="checkbox"/> EV charger	<input type="checkbox"/> pool equipment	<input type="checkbox"/> TV antenna
	<input type="checkbox"/> other:			
exclusions				
purchaser				
purchaser's solicitor			Phone:	
			Fax:	
Price	\$		Ref:	
deposit	\$		(10% of the price, unless otherwise stated)	
balance	\$			
contract date			(if not stated, the date this contract was made)	

Where there is more than one purchaser JOINT TENANTS
 tenants in common in unequal shares, specify: _____

GST AMOUNT (optional) The price includes GST of: \$

buyer's agent

Note: Clause 20.15 provides "Where this contract provides for choices, a choice in BLOCK CAPITALS applies unless a different choice is marked."

SIGNING PAGE

<p>VENDOR</p> <hr/> <p>Signed By _____</p> <p>Vendor _____</p> <p>Vendor _____</p>	<p>PURCHASER</p> <hr/> <p>Signed By _____</p> <p>Purchaser _____</p> <p>Purchaser _____</p>												
<p>VENDOR (COMPANY)</p> <hr/> <p>Signed by _____ in accordance with s127(1) of the Corporations Act 2001 by the authorised person(s) whose signature(s) appear(s) below:</p> <table style="width: 100%; border: none;"> <tr> <td style="width: 50%; border-bottom: 1px solid black; text-align: center;">Signature of authorised person</td> <td style="width: 50%; border-bottom: 1px solid black; text-align: center;">Signature of authorised person</td> </tr> <tr> <td style="width: 50%; border-bottom: 1px solid black; text-align: center;">Name of authorised person</td> <td style="width: 50%; border-bottom: 1px solid black; text-align: center;">Name of authorised person</td> </tr> <tr> <td style="width: 50%; border-bottom: 1px solid black; text-align: center;">Office held</td> <td style="width: 50%; border-bottom: 1px solid black; text-align: center;">Office held</td> </tr> </table>	Signature of authorised person	Signature of authorised person	Name of authorised person	Name of authorised person	Office held	Office held	<p>PURCHASER (COMPANY)</p> <hr/> <p>Signed by _____ in accordance with s127(1) of the Corporations Act 2001 by the authorised person(s) whose signature(s) appear(s) below:</p> <table style="width: 100%; border: none;"> <tr> <td style="width: 50%; border-bottom: 1px solid black; text-align: center;">Signature of authorised person</td> <td style="width: 50%; border-bottom: 1px solid black; text-align: center;">Signature of authorised person</td> </tr> <tr> <td style="width: 50%; border-bottom: 1px solid black; text-align: center;">Name of authorised person</td> <td style="width: 50%; border-bottom: 1px solid black; text-align: center;">Name of authorised person</td> </tr> <tr> <td style="width: 50%; border-bottom: 1px solid black; text-align: center;">Office held</td> <td style="width: 50%; border-bottom: 1px solid black; text-align: center;">Office held</td> </tr> </table>	Signature of authorised person	Signature of authorised person	Name of authorised person	Name of authorised person	Office held	Office held
Signature of authorised person	Signature of authorised person												
Name of authorised person	Name of authorised person												
Office held	Office held												
Signature of authorised person	Signature of authorised person												
Name of authorised person	Name of authorised person												
Office held	Office held												

vendor agrees to accept a **deposit-bond**

NO yes

Nominated Electronic Lodgment Network (ELN) (clause 4)

PEXA

Manual transaction (clause 30)

NO yes

(if yes, vendor must provide further details, including any applicable exception, in the space below):

Tax information (the parties promise this is correct as far as each party is aware)

land tax is adjustable

NO yes

GST: Taxable supply

NO yes in full yes to an extent

Margin scheme will be used in making the taxable supply

NO yes

This sale is not a taxable supply because (one or more of the following may apply) the sale is:

- not made in the course or furtherance of an enterprise that the vendor carries on (section 9-5(b))
- by a vendor who is neither registered nor required to be registered for GST (section 9-5(d))
- GST-free because the sale is the supply of a going concern under section 38-325
- GST-free because the sale is subdivided farm land or farm land supplied for farming under Subdivision 38-O
- input taxed because the sale is of eligible residential premises (sections 40-65, 40-75(2) and 195-1)

Purchaser must make an *GSTRW payment* (residential withholding payment)

NO yes (if yes, vendor must provide further details)

If the details below are not fully completed at the contract date, the vendor must provide all these details in a separate notice at least 7 days before the date for completion.

GSTRW payment (GST residential withholding payment) – further details

Frequently the supplier will be the vendor. However, sometimes further information will be required as to which entity is liable for GST, for example, if the supplier is a partnership, a trust, part of a GST group or a participant in a GST joint venture.

Supplier's name:

Supplier's ABN:

Supplier's GST branch number (if applicable):

Supplier's business address:

Supplier's representative:

Supplier's phone number:

Supplier's proportion of *GSTRW payment*: \$

If more than one supplier, provide the above details for each supplier.

Amount purchaser must pay – price multiplied by the *RW rate* (residential withholding rate): \$

Amount must be paid: AT COMPLETION at another time (specify):

Is any of the consideration not expressed as an amount in money? NO yes

If "yes", the GST inclusive market value of the non-monetary consideration: \$

Other details (including those required by regulation or the ATO forms):

List of Documents

General	Strata or community title (clause 23 of the contract)
<input checked="" type="checkbox"/> 1 property certificate for the land	<input checked="" type="checkbox"/> 33 property certificate for strata common property
<input checked="" type="checkbox"/> 2 plan of the land	<input checked="" type="checkbox"/> 34 plan creating strata common property
<input type="checkbox"/> 3 unregistered plan of the land	<input checked="" type="checkbox"/> 35 strata by-laws
<input type="checkbox"/> 4 plan of land to be subdivided	<input type="checkbox"/> 36 strata development contract or statement
<input type="checkbox"/> 5 document to be lodged with a relevant plan	<input type="checkbox"/> 37 strata management statement
<input checked="" type="checkbox"/> 6 section 10.7(2) planning certificate under Environmental Planning and Assessment Act 1979	<input type="checkbox"/> 38 strata renewal proposal
<input type="checkbox"/> 7 additional information included in that certificate under section 10.7(5)	<input type="checkbox"/> 39 strata renewal plan
<input checked="" type="checkbox"/> 8 sewerage infrastructure location diagram (service location diagram)	<input type="checkbox"/> 40 leasehold strata - lease of lot and common property
<input checked="" type="checkbox"/> 9 sewer lines location diagram (sewerage service diagram)	<input type="checkbox"/> 41 property certificate for neighbourhood property
<input type="checkbox"/> 10 document that created or may have created an easement, profit à prendre, restriction on use or positive covenant disclosed in this contract	<input type="checkbox"/> 42 plan creating neighbourhood property
<input type="checkbox"/> 11 <i>planning agreement</i>	<input type="checkbox"/> 43 neighbourhood development contract
<input type="checkbox"/> 12 section 88G certificate (positive covenant)	<input type="checkbox"/> 44 neighbourhood management statement
<input type="checkbox"/> 13 survey report	<input type="checkbox"/> 45 property certificate for precinct property
<input type="checkbox"/> 14 building information certificate or building certificate given under <i>legislation</i>	<input type="checkbox"/> 46 plan creating precinct property
<input type="checkbox"/> 15 occupation certificate	<input type="checkbox"/> 47 precinct development contract
<input type="checkbox"/> 16 lease (with every relevant memorandum or variation)	<input type="checkbox"/> 48 precinct management statement
<input type="checkbox"/> 17 other document relevant to tenancies	<input type="checkbox"/> 49 property certificate for community property
<input type="checkbox"/> 18 licence benefiting the land	<input type="checkbox"/> 50 plan creating community property
<input type="checkbox"/> 19 old system document	<input type="checkbox"/> 51 community development contract
<input type="checkbox"/> 20 Crown purchase statement of account	<input type="checkbox"/> 52 community management statement
<input type="checkbox"/> 21 building management statement	<input type="checkbox"/> 53 document disclosing a change of by-laws
<input checked="" type="checkbox"/> 22 form of requisitions	<input type="checkbox"/> 54 document disclosing a change in a development or management contract or statement
<input type="checkbox"/> 23 <i>clearance certificate</i>	<input type="checkbox"/> 55 document disclosing a change in boundaries
<input type="checkbox"/> 24 land tax certificate	<input type="checkbox"/> 56 information certificate under Strata Schemes Management Act 2015
Home Building Act 1989	<input type="checkbox"/> 57 information certificate under Community Land Management Act 1989
<input type="checkbox"/> 25 insurance certificate	<input type="checkbox"/> 58 disclosure statement - off the plan contract
<input type="checkbox"/> 26 brochure or warning	<input type="checkbox"/> 59 other document relevant to off the plan contract
<input type="checkbox"/> 27 evidence of alternative indemnity cover	Other
Swimming Pools Act 1992	<input type="checkbox"/> 60
<input type="checkbox"/> 28 certificate of compliance	
<input type="checkbox"/> 29 evidence of registration	
<input type="checkbox"/> 30 relevant occupation certificate	
<input type="checkbox"/> 31 certificate of non-compliance	
<input type="checkbox"/> 32 detailed reasons of non-compliance	

HOLDER OF STRATA OR COMMUNITY TITLE RECORDS – Name, address, email address and telephone number

Robinson Strata Management
Suite 2/16 Rodborough Rd, Frenchs Forest NSW 2086

Phone: (02) 9907 5000
Email: strata@robinsonstrata.com.au

COOLING-OFF CERTIFICATE

PURSUANT TO SECTION 66W OF THE CONVEYANCING ACT, 1919

I, _____ of _____

certify as follows:-

- (a) I am a Solicitor/Licensed Conveyancer currently admitted to practise in New South Wales.
- (b) I am giving this Certificate in accordance with Section 66W of the Conveyancing Act, 1919 with reference to a Contract for the sale of property referred to in Item 1 of the Schedule hereto ("Property") from the Vendor referred to in Item 2 of the Schedule hereto ("Vendor") to the Purchaser referred to in Item 3 of the Schedule hereto ("Purchaser") in order that there is no cooling-off period in relation to the Contract.
- (c) I do not act for the Vendor and am not employed in the legal practice of a Solicitor/Licensed Conveyancer acting for the Vendor nor am I a member or employee of the firm of which a Solicitor/Licensed Conveyancer acting for the Vendor is a member or employee.
- (d) I have explained to the Purchaser:
 - i. the effect of the Contract for the purchase of that property;
 - ii. the nature of this Certificate;
 - iii. the effect of giving this Certificate to the Vendor, ie. that there is no cooling off period in relation to the Contract.

SCHEDULE

Item 1 ("Property") :

Item 2 ("Vendor") :

Item 3 ("Purchaser") :

Date:

.....
Solicitor/Licensed Conveyancer

IMPORTANT NOTICE TO VENDORS AND PURCHASERS

Before signing this contract you should ensure that you understand your rights and obligations, some of which are not written in this contract but are implied by law.

WARNING—SMOKE ALARMS

The owners of certain types of buildings and strata lots must have smoke alarms, or in certain cases heat alarms, installed in the building or lot in accordance with regulations under the *Environmental Planning and Assessment Act 1979*. It is an offence not to comply. It is also an offence to remove or interfere with a smoke alarm or heat alarm. Penalties apply.

WARNING—LOOSE-FILL ASBESTOS INSULATION

Before purchasing land that includes residential premises, within the meaning of the *Home Building Act 1989*, Part 8, Division 1A, built before 1985, a purchaser is strongly advised to consider the possibility that the premises may contain loose-fill asbestos insulation, within the meaning of the *Home Building Act 1989*, Part 8, Division 1A. In particular, a purchaser should—

- (a) search the Register required to be maintained under the *Home Building Act 1989*, Part 8, Division 1A, and
- (b) ask the relevant local council whether it holds records showing that the residential premises contain loose-fill asbestos insulation.

For further information about loose-fill asbestos insulation, including areas in which residential premises have been identified as containing loose-fill asbestos insulation, contact NSW Fair Trading.

Cooling off period (purchaser's rights)

- 1 This is the statement required by the *Conveyancing Act 1919*, section 66X. This statement applies to a contract for the sale of residential property.
- 2 **EXCEPT** in the circumstances listed in paragraph 3, the purchaser may rescind the contract before 5pm on—
 - (a) for an off the plan contract—the tenth business day after the day on which the contract was made, or
 - (b) in any other case—the fifth business day after the day on which the contract was made.
- 3 There is **NO COOLING OFF PERIOD**—
 - (a) if, at or before the time the contract is made, the purchaser gives to the vendor, or the vendor's solicitor or agent, a certificate that complies with the Act, section 66W, or
 - (b) if the property is sold by public auction, or
 - (c) if the contract is made on the same day as the property was offered for sale by public auction but passed in, or
 - (d) if the contract is made in consequence of the exercise of an option to purchase the property, other than an option that is void under the Act, section 66ZG.
- 4 A purchaser exercising the right to cool off by rescinding the contract forfeits 0.25% of the purchase price of the property to the vendor.
- 5 The vendor is entitled to recover the forfeited amount from an amount paid by the purchaser as a deposit under the contract. The purchaser is entitled to a refund of any balance.

DISPUTES

If you get into a dispute with the other party, the Law Society and Real Estate Institute encourage you to use informal procedures such as negotiation, independent expert appraisal, the Law Society Conveyancing Dispute Resolution Scheme or mediation (for example mediation under the Law Society Mediation Program).

AUCTIONS

Regulations made under the Property and Stock Agents Act 2002 prescribe a number of conditions applying to sales by auction.

WARNINGS

1. **Various Acts of Parliament and other matters can affect the rights of the parties to this contract. Some important matters are actions, claims, decisions, licences, notices, orders, proposals or rights of way involving:**

APA Group Australian Taxation Office Council County Council Department of Planning and Environment Department of Primary Industries Electricity and gas Land and Housing Corporation Local Land Services	NSW Department of Education NSW Fair Trading Owner of adjoining land Privacy Public Works Advisory Subsidence Advisory NSW Telecommunications Transport for NSW Water, sewerage or drainage authority
---	--

If you think that any of these matters affects the property, tell your solicitor.
2. **A lease may be affected by the Agricultural Tenancies Act 1990, the Residential Tenancies Act 2010 or the Retail Leases Act 1994.**
3. **If any purchase money is owing to the Crown, it will become payable before obtaining consent, or if no consent is needed, when the transfer is registered.**
4. **If a consent to transfer is required under legislation, see clause 27 as to the obligations of the parties.**
5. **The vendor should continue the vendor's insurance until completion. If the vendor wants to give the purchaser possession before completion, the vendor should first ask the insurer to confirm this will not affect the insurance.**
6. **Most purchasers will have to pay transfer duty (and, sometimes, if the purchaser is not an Australian citizen, surcharge purchaser duty) on this contract. Some purchasers may be eligible to choose to pay first home buyer choice property tax instead of transfer duty. If a payment is not made on time, interest and penalties may be incurred.**
7. **If the purchaser agrees to the release of deposit, the purchaser's right to recover the deposit may stand behind the rights of others (for example the vendor's mortgagee).**
8. **The purchaser should arrange insurance as appropriate.**
9. **Some transactions involving personal property may be affected by the Personal Property Securities Act 2009.**
10. **A purchaser should be satisfied that finance will be available at the time of completing the purchase.**
11. **Where the market value of the property is at or above a legislated amount, the purchaser may have to comply with a foreign resident capital gains withholding payment obligation (even if the vendor is not a foreign resident). If so, this will affect the amount available to the vendor on completion.**
12. **Purchasers of some residential properties may have to withhold part of the purchase price to be credited towards the GST liability of the vendor. If so, this will also affect the amount available to the vendor. More information is available from the ATO.**

The vendor sells and the purchaser buys the *property* for the price under these provisions instead of Schedule 3 Conveyancing Act 1919, subject to any *legislation* that cannot be excluded.

1 Definitions (a term in italics is a defined term)

- 1.1 In this contract, these terms (in any form) mean –
- | | |
|-------------------------------|---|
| <i>adjustment date</i> | the earlier of the giving of possession to the purchaser or completion; |
| <i>adjustment figures</i> | details of the adjustments to be made to the price under clause 14; |
| <i>authorised Subscriber</i> | a <i>Subscriber</i> (not being a <i>party's solicitor</i>) named in a notice served by a <i>party</i> as being authorised for the purposes of clause 20.6.8; |
| <i>bank</i> | the Reserve Bank of Australia or an authorised deposit-taking institution which is a bank, a building society or a credit union; |
| <i>business day</i> | any day except a bank or public holiday throughout NSW or a Saturday or Sunday; |
| <i>cheque</i> | a cheque that is not postdated or stale; |
| <i>clearance certificate</i> | a certificate within the meaning of s14-220 of Schedule 1 to the <i>TA Act</i> , that covers one or more days falling within the period from and including the contract date to completion; |
| <i>completion time</i> | the time of day at which completion is to occur; |
| <i>conveyancing rules</i> | the rules made under s12E of the Real Property Act 1900; |
| <i>deposit-bond</i> | a deposit bond or guarantee with each of the following approved by the vendor – <ul style="list-style-type: none"> ● the issuer; ● the expiry date (if any); and ● the amount; |
| <i>depositholder</i> | vendor's agent (or if no vendor's agent is named in this contract, the vendor's <i>solicitor</i> , or if no vendor's <i>solicitor</i> is named in this contract, the buyer's agent); |
| <i>discharging mortgagee</i> | any discharging mortgagee, chargee, covenant chargee or caveator whose provision of a <i>Digitally Signed</i> discharge of mortgage, discharge of charge or withdrawal of caveat is required in order for unencumbered title to the <i>property</i> to be transferred to the purchaser; |
| <i>document of title</i> | document relevant to the title or the passing of title; |
| <i>ECNL</i> | the Electronic Conveyancing National Law (NSW); |
| <i>electronic document</i> | a dealing as defined in the Real Property Act 1900 which may be created and <i>Digitally Signed</i> in an <i>Electronic Workspace</i> ; |
| <i>electronic transaction</i> | a <i>Conveyancing Transaction</i> to be conducted for the <i>parties</i> by their legal representatives as <i>Subscribers</i> using an <i>ELN</i> and in accordance with the <i>ECNL</i> and the <i>participation rules</i> ; |
| <i>electronic transfer</i> | a transfer of land under the Real Property Act 1900 for the <i>property</i> to be prepared and <i>Digitally Signed</i> in the <i>Electronic Workspace</i> established for the purposes of the <i>parties' Conveyancing Transaction</i> ; |
| <i>FRCGW percentage</i> | the percentage mentioned in s14-200(3)(a) of Schedule 1 to the <i>TA Act</i> (12.5% as at 1 July 2017); |
| <i>FRCGW remittance</i> | a remittance which the purchaser must make under s14-200 of Schedule 1 to the <i>TA Act</i> , being the lesser of the <i>FRCGW percentage</i> of the price (inclusive of GST, if any) and the amount specified in a <i>variation served by a party</i> ; |
| <i>GST Act</i> | A New Tax System (Goods and Services Tax) Act 1999; |
| <i>GST rate</i> | the rate mentioned in s4 of A New Tax System (Goods and Services Tax Imposition - General) Act 1999 (10% as at 1 July 2000); |
| <i>GSTRW payment</i> | a payment which the purchaser must make under s14-250 of Schedule 1 to the <i>TA Act</i> (the price multiplied by the <i>GSTRW rate</i>); |
| <i>GSTRW rate</i> | the rate determined under ss14-250(6), (8) or (9) of Schedule 1 to the <i>TA Act</i> (as at 1 July 2018, usually 7% of the price if the margin scheme applies, 1/11 th if not); |
| <i>incoming mortgagee</i> | any mortgagee who is to provide finance to the purchaser on the security of the <i>property</i> and to enable the purchaser to pay the whole or part of the price; |
| <i>legislation</i> | an Act or a by-law, ordinance, regulation or rule made under an Act; |
| <i>manual transaction</i> | a <i>Conveyancing Transaction</i> in which a dealing forming part of the <i>Lodgment Case</i> at or following completion cannot be <i>Digitally Signed</i> ; |
| <i>normally</i> | subject to any other provision of this contract; |
| <i>participation rules</i> | the participation rules as determined by the <i>ECNL</i> ; |
| <i>party</i> | each of the vendor and the purchaser; |
| <i>property</i> | the land, the improvements, all fixtures and the inclusions, but not the exclusions; |
| <i>planning agreement</i> | a valid voluntary agreement within the meaning of s7.4 of the Environmental Planning and Assessment Act 1979 entered into in relation to the <i>property</i> ; |
| <i>populate</i> | to complete data fields in the <i>Electronic Workspace</i> ; |

<i>requisition</i>	an objection, question or requisition (but the term does not include a claim);
<i>rescind</i>	rescind this contract from the beginning;
<i>serve</i>	serve in writing on the other <i>party</i> ;
<i>settlement cheque</i>	an unendorsed <i>cheque</i> made payable to the person to be paid and – <ul style="list-style-type: none"> • issued by a <i>bank</i> and drawn on itself; or • if authorised in writing by the vendor or the vendor's <i>solicitor</i>, some other <i>cheque</i>;
<i>solicitor</i>	in relation to a <i>party</i> , the <i>party's</i> solicitor or licensed conveyancer named in this contract or in a notice <i>served</i> by the <i>party</i> ;
<i>TA Act</i>	Taxation Administration Act 1953;
<i>terminate</i>	terminate this contract for breach;
<i>title data</i>	the details of the title to the <i>property</i> made available to the <i>Electronic Workspace</i> by the <i>Land Registry</i> ;
<i>variation</i>	a variation made under s14-235 of Schedule 1 to the <i>TA Act</i> ;
<i>within</i>	in relation to a period, at any time before or during the period; and
<i>work order</i>	a valid direction, notice or order that requires work to be done or money to be spent on or in relation to the <i>property</i> or any adjoining footpath or road (but the term does not include a notice under s22E of the Swimming Pools Act 1992 or clause 22 of the Swimming Pools Regulation 2018).

- 1.2 Words and phrases used in this contract (italicised and in Title Case, such as *Conveyancing Transaction*, *Digitally Signed*, *Electronic Workspace*, *ELN*, *ELNO*, *Land Registry*, *Lodgment Case* and *Subscriber*) have the meanings given in the *participation rules*.

2 Deposit and other payments before completion

- 2.1 The purchaser must pay the deposit to the *depositholder* as stakeholder.
- 2.2 *Normally*, the purchaser must pay the deposit on the making of this contract, and this time is essential.
- 2.3 If this contract requires the purchaser to pay any of the deposit by a later time, that time is also essential.
- 2.4 The purchaser can pay any of the deposit by –
- 2.4.1 giving cash (up to \$2,000) to the *depositholder*;
- 2.4.2 unconditionally giving a *cheque* to the *depositholder* or to the vendor, vendor's agent or vendor's *solicitor* for sending to the *depositholder*; or
- 2.4.3 electronic funds transfer to the *depositholder's* nominated account and, if requested by the vendor or the *depositholder*, providing evidence of that transfer.
- 2.5 The vendor can *terminate* if –
- 2.5.1 any of the deposit is not paid on time;
- 2.5.2 a *cheque* for any of the deposit is not honoured on presentation; or
- 2.5.3 a payment under clause 2.4.3 is not received in the *depositholder's* nominated account by 5.00 pm on the third *business day* after the time for payment.
- This right to *terminate* is lost as soon as the deposit is paid in full.
- 2.6 If the vendor accepts a *deposit-bond* for the deposit, clauses 2.1 to 2.5 do not apply.
- 2.7 If the vendor accepts a *deposit-bond* for part of the deposit, clauses 2.1 to 2.5 apply only to the balance.
- 2.8 If any of the deposit or of the balance of the price is paid before completion to the vendor or as the vendor directs, it is a charge on the land in favour of the purchaser until *termination* by the vendor or completion, subject to any existing right.
- 2.9 If each *party* tells the *depositholder* that the deposit is to be invested, the *depositholder* is to invest the deposit (at the risk of the *party* who becomes entitled to it) with a *bank*, in an interest-bearing account in NSW, payable at call, with interest to be reinvested, and pay the interest to the *parties* equally, after deduction of all proper government taxes and financial institution charges and other charges.

3 Deposit-bond

- 3.1 This clause applies only if the vendor accepts a *deposit-bond* for the deposit (or part of it).
- 3.2 The purchaser must provide the *deposit-bond* to the vendor's *solicitor* (or if no solicitor the *depositholder*) at or before the making of this contract and this time is essential.
- 3.3 If the *deposit-bond* has an expiry date and completion does not occur by the date which is 14 days before the expiry date, the purchaser must *serve* a replacement *deposit-bond* at least 7 days before the expiry date. The time for service is essential.
- 3.4 The vendor must approve a replacement *deposit-bond* if –
- 3.4.1 it is from the same issuer and for the same amount as the earlier *deposit-bond*; and
- 3.4.2 it has an expiry date at least three months after its date of issue.
- 3.5 A breach of clauses 3.2 or 3.3 entitles the vendor to *terminate*. The right to *terminate* is lost as soon as –
- 3.5.1 the purchaser *serves* a replacement *deposit-bond*; or
- 3.5.2 the deposit is paid in full under clause 2.
- 3.6 Clauses 3.3 and 3.4 can operate more than once.

- 3.7 If the purchaser *serves* a replacement *deposit-bond*, the vendor must *serve* the earlier *deposit-bond*.
- 3.8 The amount of any *deposit-bond* does not form part of the price for the purposes of clause 16.5.
- 3.9 The vendor must give the purchaser any original *deposit-bond* –
- 3.9.1 on completion; or
- 3.9.2 if this contract is *rescinded*.
- 3.10 If this contract is *terminated* by the vendor –
- 3.10.1 *normally*, the vendor can immediately demand payment from the issuer of the *deposit-bond*; or
- 3.10.2 if the purchaser *serves* prior to *termination* a notice disputing the vendor's right to *terminate*, the vendor must forward any original *deposit-bond* (or its proceeds if called up) to the *depositholder* as stakeholder.
- 3.11 If this contract is *terminated* by the purchaser –
- 3.11.1 *normally*, the vendor must give the purchaser any original *deposit-bond*; or
- 3.11.2 if the vendor *serves* prior to *termination* a notice disputing the purchaser's right to *terminate*, the vendor must forward any original *deposit-bond* (or its proceeds if called up) to the *depositholder* as stakeholder.
- 4 Electronic transaction**
- 4.1 This *Conveyancing Transaction* is to be conducted as an *electronic transaction* unless –
- 4.1.1 the contract says this transaction is a *manual transaction*, giving the reason, or
- 4.1.2 a *party* *serves* a notice stating why the transaction is a *manual transaction*, in which case the *parties* do not have to complete earlier than 14 days after *service* of the notice, and clause 21.3 does not apply to this provision,
- and in both cases clause 30 applies.
- 4.2 If, because of clause 4.1.2, this *Conveyancing Transaction* is to be conducted as a *manual transaction* –
- 4.2.1 each *party* must –
- bear equally any disbursements or fees; and
 - otherwise bear that *party's* own costs;
- incurred because this *Conveyancing Transaction* was to be conducted as an *electronic transaction*; and
- 4.2.2 if a *party* has paid all of a disbursement or fee which, by reason of this clause, is to be borne equally by the *parties*, that amount must be adjusted under clause 14.
- 4.3 The *parties* must conduct the *electronic transaction* –
- 4.3.1 in accordance with the *participation rules* and the *ECNL*; and
- 4.3.2 using the nominated *ELN*, unless the *parties* otherwise agree. This clause 4.3.2 does not prevent a *party* using an *ELN* which can interoperate with the nominated *ELN*.
- 4.4 A *party* must pay the fees and charges payable by that *party* to the *ELNO* and the *Land Registry*.
- 4.5 *Normally*, the vendor must *within 7 days* of the contract date create and *populate* an *Electronic Workspace* with *title data* and the date for completion, and invite the purchaser to the *Electronic Workspace*.
- 4.6 If the vendor has not created an *Electronic Workspace* in accordance with clause 4.5, the purchaser may create and *populate* an *Electronic Workspace* and, if it does so, the purchaser must invite the vendor to the *Electronic Workspace*.
- 4.7 The *parties* must, as applicable to their role in the *Conveyancing Transaction* and the steps taken under clauses 4.5 or 4.6 –
- 4.7.1 promptly join the *Electronic Workspace* after receipt of an invitation;
- 4.7.2 create and *populate* an *electronic transfer*;
- 4.7.3 invite any *discharging mortgagee* or *incoming mortgagee* to join the *Electronic Workspace*; and
- 4.7.4 *populate* the *Electronic Workspace* with a nominated *completion time*.
- 4.8 If the transferee in the *electronic transfer* is not the purchaser, the purchaser must give the vendor a direction signed by the purchaser personally for that transfer.
- 4.9 The vendor can require the purchaser to include a covenant or easement in the *electronic transfer* only if this contract contains the wording of the proposed covenant or easement, and a description of the land burdened and benefited.
- 4.10 If the purchaser must make a *GSTRW payment* or an *FRCGW remittance*, the purchaser must *populate* the *Electronic Workspace* with the payment details for the *GSTRW payment* or *FRCGW remittance* payable to the Deputy Commissioner of Taxation at least 2 *business days* before the date for completion.
- 4.11 Before completion, the *parties* must ensure that –
- 4.11.1 all *electronic documents* which a *party* must *Digitally Sign* to complete the *electronic transaction* are *populated* and *Digitally Signed*;
- 4.11.2 all certifications required by the *ECNL* are properly given; and
- 4.11.3 they do everything else in the *Electronic Workspace* which that *party* must do to enable the *electronic transaction* to proceed to completion.
- 4.12 If the computer systems of any of the *Land Registry*, the *ELNO*, Revenue NSW or the Reserve Bank of Australia are inoperative for any reason at the *completion time* agreed by the *parties*, a failure to complete this contract for that reason is not a default under this contract on the part of either *party*.

- 4.13 If the computer systems of the *Land Registry* are inoperative for any reason at the *completion time* agreed by the *parties*, and the *parties* choose that financial settlement is to occur despite this, then on financial settlement occurring –
- 4.13.1 all *electronic documents Digitally Signed* by the vendor and any discharge of mortgage, withdrawal of caveat or other *electronic document* forming part of the *Lodgment Case* for the *electronic transaction* are taken to have been unconditionally and irrevocably delivered to the purchaser or the purchaser's mortgagee at the time of financial settlement together with the right to deal with the land; and
- 4.13.2 the vendor is taken to have no legal or equitable interest in the *property*.
- 4.14 If the *parties* do not agree about the delivery before completion of one or more documents or things that cannot be delivered through the *Electronic Workspace*, the *party* required to deliver the documents or things –
- 4.14.1 holds them on completion in escrow for the benefit of; and
- 4.14.2 must immediately after completion deliver the documents or things to, or as directed by; the *party* entitled to them.

5 Requisitions

- 5.1 If a form of *requisitions* is attached to this contract, the purchaser is taken to have made those *requisitions*.
- 5.2 If the purchaser is or becomes entitled to make any other *requisition*, the purchaser can make it only by *servicing* it –
- 5.2.1 if it arises out of this contract or it is a general question about the *property* or title - *within 21 days* after the contract date;
- 5.2.2 if it arises out of anything *served* by the vendor - *within 21 days* after the later of the contract date and that *service*; and
- 5.2.3 in any other case - *within a reasonable time*.

6 Error or misdescription

- 6.1 *Normally*, the purchaser can (but only before completion) claim compensation for an error or misdescription in this contract (as to the *property*, the title or anything else and whether substantial or not).
- 6.2 This clause applies even if the purchaser did not take notice of or rely on anything in this contract containing or giving rise to the error or misdescription.
- 6.3 However, this clause does not apply to the extent the purchaser knows the true position.

7 Claims by purchaser

- Normally*, the purchaser can make a claim (including a claim under clause 6) before completion only by *servicing* it with a statement of the amount claimed, and if the purchaser makes one or more claims before completion –
- 7.1 the vendor can *rescind* if in the case of claims that are not claims for delay –
- 7.1.1 the total amount claimed exceeds 5% of the price;
- 7.1.2 the vendor *serves* notice of intention to *rescind*; and
- 7.1.3 the purchaser does not *serve* notice waiving the claims *within 14 days* after that *service*; and
- 7.2 if the vendor does not *rescind*, the *parties* must complete and if this contract is completed –
- 7.2.1 the lesser of the total amount claimed and 10% of the price must be paid out of the price to and held by the *depositholder* until the claims are finalised or lapse;
- 7.2.2 the amount held is to be invested in accordance with clause 2.9;
- 7.2.3 the claims must be finalised by an arbitrator appointed by the *parties* or, if an appointment is not made *within 1 month* of completion, by an arbitrator appointed by the President of the Law Society at the request of a *party* (in the latter case the *parties* are bound by the terms of the Conveyancing Arbitration Rules approved by the Law Society as at the date of the appointment);
- 7.2.4 the purchaser is not entitled, in respect of the claims, to more than the total amount claimed and the costs of the purchaser;
- 7.2.5 net interest on the amount held must be paid to the *parties* in the same proportion as the amount held is paid; and
- 7.2.6 if the *parties* do not appoint an arbitrator and neither *party* requests the President to appoint an arbitrator *within 3 months* after completion, the claims lapse and the amount belongs to the vendor.

8 Vendor's rights and obligations

- 8.1 The vendor can *rescind* if –
- 8.1.1 the vendor is, on reasonable grounds, unable or unwilling to comply with a *requisition*;
- 8.1.2 the vendor *serves* a notice of intention to *rescind* that specifies the *requisition* and those grounds; and
- 8.1.3 the purchaser does not *serve* a notice waiving the *requisition within 14 days* after that *service*.

- 8.2 If the vendor does not comply with this contract (or a notice under or relating to it) in an essential respect, the purchaser can *terminate* by *servicing* a notice. After the *termination* –
- 8.2.1 the purchaser can recover the deposit and any other money paid by the purchaser under this contract;
- 8.2.2 the purchaser can sue the vendor to recover damages for breach of contract; and
- 8.2.3 if the purchaser has been in possession a *party* can claim for a reasonable adjustment.

9 Purchaser's default

If the purchaser does not comply with this contract (or a notice under or relating to it) in an essential respect, the vendor can *terminate* by *servicing* a notice. After the *termination* the vendor can –

- 9.1 keep or recover the deposit (to a maximum of 10% of the price);
- 9.2 hold any other money paid by the purchaser under this contract as security for anything recoverable under this clause –
- 9.2.1 for 12 months after the *termination*; or
- 9.2.2 if the vendor commences proceedings under this clause *within* 12 months, until those proceedings are concluded; and
- 9.3 sue the purchaser either –
- 9.3.1 where the vendor has resold the *property* under a contract made *within* 12 months after the *termination*, to recover –
- the deficiency on resale (with credit for any of the deposit kept or recovered and after allowance for any capital gains tax or goods and services tax payable on anything recovered under this clause); and
 - the reasonable costs and expenses arising out of the purchaser's non-compliance with this contract or the notice and of resale and any attempted resale; or
- 9.3.2 to recover damages for breach of contract.

10 Restrictions on rights of purchaser

- 10.1 The purchaser cannot make a claim or *requisition* or *rescind* or *terminate* in respect of –
- 10.1.1 the ownership or location of any fence as defined in the Dividing Fences Act 1991;
- 10.1.2 a service for the *property* being a joint service or passing through another property, or any service for another property passing through the *property* ('service' includes air, communication, drainage, electricity, garbage, gas, oil, radio, sewerage, telephone, television or water service);
- 10.1.3 a wall being or not being a party wall in any sense of that term or the *property* being affected by an easement for support or not having the benefit of an easement for support;
- 10.1.4 any change in the *property* due to fair wear and tear before completion;
- 10.1.5 a promise, representation or statement about this contract, the *property* or the title, not set out or referred to in this contract;
- 10.1.6 a condition, exception, reservation or restriction in a Crown grant;
- 10.1.7 the existence of any authority or licence to explore or prospect for gas, minerals or petroleum;
- 10.1.8 any easement or restriction on use the substance of either of which is disclosed in this contract or any non-compliance with the easement or restriction on use; or
- 10.1.9 anything the substance of which is disclosed in this contract (except a caveat, charge, mortgage, priority notice or writ).
- 10.2 The purchaser cannot *rescind* or *terminate* only because of a defect in title to or quality of the inclusions.
- 10.3 *Normally*, the purchaser cannot make a claim or *requisition* or *rescind* or *terminate* or require the vendor to change the nature of the title disclosed in this contract (for example, to remove a caution evidencing qualified title, or to lodge a plan of survey as regards limited title).

11 Compliance with work orders

- 11.1 *Normally*, the vendor must by completion comply with a *work order* made on or before the contract date and if this contract is completed the purchaser must comply with any other *work order*.
- 11.2 If the purchaser complies with a *work order*, and this contract is *rescinded* or *terminated*, the vendor must pay the expense of compliance to the purchaser.

12 Certificates and inspections

The vendor must do everything reasonable to enable the purchaser, subject to the rights of any tenant –

- 12.1 to have the *property* inspected to obtain any certificate or report reasonably required;
- 12.2 to apply (if necessary in the name of the vendor) for –
- 12.2.1 any certificate that can be given in respect of the *property* under *legislation*; or
- 12.2.2 a copy of any approval, certificate, consent, direction, notice or order in respect of the *property* given under *legislation*, even if given after the contract date; and
- 12.3 to make 1 inspection of the *property* in the 3 days before a time appointed for completion.

13 Goods and services tax (GST)

- 13.1 Terms used in this clause which are not defined elsewhere in this contract and have a defined meaning in the *GST Act* have the same meaning in this clause.
- 13.2 *Normally*, if a *party* must pay the price or any other amount to the other *party* under this contract, GST is not to be added to the price or amount.
- 13.3 If under this contract a *party* must make an adjustment or payment for an expense of another party or pay an expense payable by or to a third party (for example, under clauses 14 or 20.7) –
- 13.3.1 the *party* must adjust or pay on completion any GST added to or included in the expense; but
- 13.3.2 the amount of the expense must be reduced to the extent the party receiving the adjustment or payment (or the representative member of a GST group of which that party is a member) is entitled to an input tax credit for the expense; and
- 13.3.3 if the adjustment or payment under this contract is consideration for a taxable supply, an amount for GST must be added at the *GST rate*.
- 13.4 If this contract says this sale is the supply of a going concern –
- 13.4.1 the *parties* agree the supply of the *property* is a supply of a going concern;
- 13.4.2 the vendor must, between the contract date and completion, carry on the enterprise conducted on the land in a proper and business-like way;
- 13.4.3 if the purchaser is not registered by the date for completion, the *parties* must complete and the purchaser must pay on completion, in addition to the price, an amount being the price multiplied by the *GST rate* ("the retention sum"). The retention sum is to be held by the *depositholder* and dealt with as follows –
- if *within* 3 months of completion the purchaser serves a letter from the Australian Taxation Office stating the purchaser is registered with a date of effect of registration on or before completion, the *depositholder* is to pay the retention sum to the purchaser; but
 - if the purchaser does not serve that letter *within* 3 months of completion, the *depositholder* is to pay the retention sum to the vendor; and
- 13.4.4 if the vendor, despite clause 13.4.1, serves a letter from the Australian Taxation Office stating the vendor has to pay GST on the supply, the purchaser must pay to the vendor on demand the amount of GST assessed.
- 13.5 *Normally*, the vendor promises the margin scheme will not apply to the supply of the *property*.
- 13.6 If this contract says the margin scheme is to apply in making the taxable supply, the *parties* agree that the margin scheme is to apply to the sale of the *property*.
- 13.7 If this contract says the sale is not a taxable supply –
- 13.7.1 the purchaser promises that the *property* will not be used and represents that the purchaser does not intend the *property* (or any part of the *property*) to be used in a way that could make the sale a taxable supply to any extent; and
- 13.7.2 the purchaser must pay the vendor on completion in addition to the price an amount calculated by multiplying the price by the *GST rate* if this sale is a taxable supply to any extent because of –
- a breach of clause 13.7.1; or
 - something else known to the purchaser but not the vendor.
- 13.8 If this contract says this sale is a taxable supply in full and does not say the margin scheme applies to the *property*, the vendor must pay the purchaser on completion an amount of one-eleventh of the price if –
- 13.8.1 this sale is not a taxable supply in full; or
- 13.8.2 the margin scheme applies to the *property* (or any part of the *property*).
- 13.9 If this contract says this sale is a taxable supply to an extent –
- 13.9.1 clause 13.7.1 does not apply to any part of the *property* which is identified as being a taxable supply; and
- 13.9.2 the payments mentioned in clauses 13.7 and 13.8 are to be recalculated by multiplying the relevant payment by the proportion of the price which represents the value of that part of the *property* to which the clause applies (the proportion to be expressed as a number between 0 and 1). Any evidence of value must be obtained at the expense of the vendor.
- 13.10 *Normally*, on completion the vendor must give the recipient of the supply a tax invoice for any taxable supply by the vendor by or under this contract.
- 13.11 The vendor does not have to give the purchaser a tax invoice if the margin scheme applies to a taxable supply.
- 13.12 If the vendor is liable for GST on rents or profits due to issuing an invoice or receiving consideration before completion, any adjustment of those amounts must exclude an amount equal to the vendor's GST liability.
- 13.13 If the vendor serves details of a *GSTRW payment* which the purchaser must make, the purchaser does not have to complete earlier than 5 *business days* after that *service* and clause 21.3 does not apply to this provision.
- 13.14 If the purchaser must make a *GSTRW payment* the purchaser must, at least 2 *business days* before the date for completion, serve evidence of submission of a *GSTRW payment* notification form to the Australian Taxation Office by the purchaser or, if a direction under either clause 4.8 or clause 30.4 has been given, by the transferee named in the transfer the subject of that direction.

14 Adjustments

- 14.1 *Normally*, the vendor is entitled to the rents and profits and will be liable for all rates, water, sewerage and drainage service and usage charges, land tax, levies and all other periodic outgoings up to and including the *adjustment date* after which the purchaser will be entitled and liable.
- 14.2 The *parties* must make any necessary adjustment on completion, and –
- 14.2.1 the purchaser must provide the vendor with *adjustment figures* at least 2 *business days* before the date for completion; and
- 14.2.2 the vendor must confirm the *adjustment figures* at least 1 *business day* before the date for completion.
- 14.3 If an amount that is adjustable under this contract has been reduced under *legislation*, the *parties* must on completion adjust the reduced amount.
- 14.4 The *parties* must not adjust surcharge land tax (as defined in the Land Tax Act 1956) but must adjust any other land tax for the year current at the *adjustment date* –
- 14.4.1 only if land tax has been paid or is payable for the year (whether by the vendor or by a predecessor in title) and this contract says that land tax is adjustable;
- 14.4.2 by adjusting the amount that would have been payable if at the start of the year –
- the person who owned the land owned no other land;
 - the land was not subject to a special trust or owned by a non-concessional company; and
 - if the land (or part of it) had no separate taxable value, by calculating its separate taxable value on a proportional area basis.
- 14.5 The *parties* must not adjust any first home buyer choice property tax.
- 14.6 If any other amount that is adjustable under this contract relates partly to the land and partly to other land, the *parties* must adjust it on a proportional area basis.
- 14.7 If on completion the last bill for a water, sewerage or drainage usage charge is for a period ending before the *adjustment date*, the vendor is liable for an amount calculated by dividing the bill by the number of days in the period then multiplying by the number of unbilled days up to and including the *adjustment date*.
- 14.8 The vendor is liable for any amount recoverable for work started on or before the contract date on the *property* or any adjoining footpath or road.

15 Date for completion

The *parties* must complete by the date for completion and, if they do not, a *party* can serve a notice to complete if that *party* is otherwise entitled to do so.

16 Completion

• Vendor

- 16.1 *Normally*, on completion the vendor must cause the legal title to the *property* (being the estate disclosed in this contract) to pass to the purchaser free of any charge, mortgage or other interest, subject to any necessary registration.
- 16.2 The legal title to the *property* does not pass before completion.
- 16.3 If the vendor gives the purchaser a document (other than the transfer) that needs to be lodged for registration, the vendor must pay the lodgment fee to the purchaser.
- 16.4 If a *party* serves a land tax certificate showing a charge on any of the land, by completion the vendor must do all things and pay all money required so that the charge is no longer effective against the land.

• Purchaser

- 16.5 On completion the purchaser must pay to the vendor –
- 16.5.1 the price less any –
- deposit paid;
 - *FRCGW remittance* payable;
 - *GSTRW payment*; and
 - amount payable by the vendor to the purchaser under this contract; and
- 16.5.2 any other amount payable by the purchaser under this contract.
- 16.6 If any of the deposit is not covered by a *deposit-bond*, at least 1 *business day* before the date for completion the purchaser must give the vendor an order signed by the purchaser authorising the *depositholder* to account to the vendor for the deposit, to be held by the vendor in escrow until completion.
- 16.7 On completion the deposit belongs to the vendor.

17 Possession

- 17.1 *Normally*, the vendor must give the purchaser vacant possession of the *property* on completion.
- 17.2 The vendor does not have to give vacant possession if –
- 17.2.1 this contract says that the sale is subject to existing tenancies; and
- 17.2.2 the contract discloses the provisions of the tenancy (for example, by attaching a copy of the lease and any relevant memorandum or variation).
- 17.3 *Normally*, the purchaser can claim compensation (before or after completion) or *rescind* if any of the land is affected by a protected tenancy (a tenancy affected by Schedule 2, Part 7 of the Residential Tenancies Act 2010).

18 Possession before completion

- 18.1 This clause applies only if the vendor gives the purchaser possession of the *property* before completion.
- 18.2 The purchaser must not before completion –
- 18.2.1 let or part with possession of any of the *property*;
 - 18.2.2 make any change or structural alteration or addition to the *property*; or
 - 18.2.3 contravene any agreement between the *parties* or any direction, document, *legislation*, notice or order affecting the *property*.
- 18.3 The purchaser must until completion –
- 18.3.1 keep the *property* in good condition and repair having regard to its condition at the giving of possession; and
 - 18.3.2 allow the vendor or the vendor's authorised representative to enter and inspect it at all reasonable times.
- 18.4 The risk as to damage to the *property* passes to the purchaser immediately after the purchaser enters into possession.
- 18.5 If the purchaser does not comply with this clause, then without affecting any other right of the vendor –
- 18.5.1 the vendor can before completion, without notice, remedy the non-compliance; and
 - 18.5.2 if the vendor pays the expense of doing this, the purchaser must pay it to the vendor with interest at the rate prescribed under s101 Civil Procedure Act 2005.
- 18.6 If this contract is *rescinded* or *terminated* the purchaser must immediately vacate the *property*.
- 18.7 If the *parties* or their *solicitors* on their behalf do not agree in writing to a fee or rent, none is payable.

19 Rescission of contract

- 19.1 If this contract expressly gives a *party* a right to *rescind*, the *party* can exercise the right –
- 19.1.1 only by *servicing* a notice before completion; and
 - 19.1.2 in spite of any making of a claim or *requisition*, any attempt to satisfy a claim or *requisition*, any arbitration, litigation, mediation or negotiation or any giving or taking of possession.
- 19.2 *Normally*, if a *party* exercises a right to *rescind* expressly given by this contract or any *legislation* –
- 19.2.1 the deposit and any other money paid by the purchaser under this contract must be refunded;
 - 19.2.2 a *party* can claim for a reasonable adjustment if the purchaser has been in possession;
 - 19.2.3 a *party* can claim for damages, costs or expenses arising out of a breach of this contract; and
 - 19.2.4 a *party* will not otherwise be liable to pay the other *party* any damages, costs or expenses.

20 Miscellaneous

- 20.1 The *parties* acknowledge that anything stated in this contract to be attached was attached to this contract by the vendor before the purchaser signed it and is part of this contract.
- 20.2 Anything attached to this contract is part of this contract.
- 20.3 An area, bearing or dimension in this contract is only approximate.
- 20.4 If a *party* consists of 2 or more persons, this contract benefits and binds them separately and together.
- 20.5 A *party's solicitor* can receive any amount payable to the *party* under this contract or direct in writing that it is to be paid to another person.
- 20.6 A document under or relating to this contract is –
- 20.6.1 signed by a *party* if it is signed by the *party* or the *party's solicitor* (apart from a direction under clause 4.8 or clause 30.4);
 - 20.6.2 *served* if it is *served* by the *party* or the *party's solicitor*;
 - 20.6.3 *served* if it is *served* on the *party's solicitor*, even if the *party* has died or any of them has died;
 - 20.6.4 *served* if it is *served* in any manner provided in s170 of the Conveyancing Act 1919;
 - 20.6.5 *served* if it is sent by email or fax to the *party's solicitor*, unless in either case it is not received;
 - 20.6.6 *served* on a person if it (or a copy of it) comes into the possession of the person;
 - 20.6.7 *served* at the earliest time it is *served*, if it is *served* more than once; and
 - 20.6.8 *served* if it is provided to or by the *party's solicitor* or an *authorised Subscriber* by means of an *Electronic Workspace* created under clause 4. However, this does not apply to a notice making an obligation essential, or a notice of *rescission* or *termination*.
- 20.7 An obligation to pay an expense of another *party* of doing something is an obligation to pay –
- 20.7.1 if the *party* does the thing personally - the reasonable cost of getting someone else to do it; or
 - 20.7.2 if the *party* pays someone else to do the thing - the amount paid, to the extent it is reasonable.
- 20.8 Rights under clauses 4, 11, 13, 14, 17, 24, 30 and 31 continue after completion, whether or not other rights continue.
- 20.9 The vendor does not promise, represent or state that the purchaser has any cooling off rights.
- 20.10 The vendor does not promise, represent or state that any attached survey report is accurate or current.
- 20.11 A reference to any *legislation* (including any percentage or rate specified in *legislation*) is also a reference to any corresponding later *legislation*.
- 20.12 Each *party* must do whatever is necessary after completion to carry out the *party's* obligations under this contract.
- 20.13 Neither taking possession nor *servicing* a transfer of itself implies acceptance of the *property* or the title.

- 20.14 The details and information provided in this contract (for example, on pages 1 - 4) are, to the extent of each *party's* knowledge, true, and are part of this contract.
- 20.15 Where this contract provides for choices, a choice in BLOCK CAPITALS applies unless a different choice is marked.
- 20.16 Each *party* consents to –
- 20.16.1 any *party* signing this contract electronically; and
- 20.16.2 the making of this contract by the exchange of counterparts delivered by email, or by such other electronic means as may be agreed in writing by the *parties*.
- 20.17 Each *party* agrees that electronic signing by a *party* identifies that *party* and indicates that *party's* intention to be bound by this contract.

21 Time limits in these provisions

- 21.1 If the time for something to be done or to happen is not stated in these provisions, it is a reasonable time.
- 21.2 If there are conflicting times for something to be done or to happen, the latest of those times applies.
- 21.3 The time for one thing to be done or to happen does not extend the time for another thing to be done or to happen.
- 21.4 If the time for something to be done or to happen is the 29th, 30th or 31st day of a month, and the day does not exist, the time is instead the last day of the month.
- 21.5 If the time for something to be done or to happen is a day that is not a *business day*, the time is extended to the next *business day*, except in the case of clauses 2 and 3.2.
- 21.6 *Normally*, the time by which something must be done is fixed but not essential.

22 Foreign Acquisitions and Takeovers Act 1975

- 22.1 The purchaser promises that the Commonwealth Treasurer cannot prohibit and has not prohibited the transfer under the Foreign Acquisitions and Takeovers Act 1975.
- 22.2 This promise is essential and a breach of it entitles the vendor to *terminate*.

23 Strata or community title

• Definitions and modifications

- 23.1 This clause applies only if the land (or part of it) is a lot in a strata, neighbourhood, precinct or community scheme (or on completion is to be a lot in a scheme of that kind).
- 23.2 In this contract –
- 23.2.1 'change', in relation to a scheme, means –
- a registered or registrable change from by-laws set out in this contract;
 - a change from a development or management contract or statement set out in this contract; or
 - a change in the boundaries of common property;
- 23.2.2 'common property' includes association property for the scheme or any higher scheme;
- 23.2.3 'contribution' includes an amount payable under a by-law;
- 23.2.4 'information certificate' includes a certificate under s184 Strata Schemes Management Act 2015 and s171 Community Land Management Act 2021;
- 23.2.5 'interest notice' includes a strata interest notice under s22 Strata Schemes Management Act 2015 and an association interest notice under s20 Community Land Management Act 2021;
- 23.2.6 'normal expenses', in relation to an owners corporation for a scheme, means normal operating expenses usually payable from the administrative fund of an owners corporation for a scheme of the same kind;
- 23.2.7 'owners corporation' means the owners corporation or the association for the scheme or any higher scheme;
- 23.2.8 'the *property*' includes any interest in common property for the scheme associated with the lot; and
- 23.2.9 'special expenses', in relation to an owners corporation, means its actual, contingent or expected expenses, except to the extent they are –
- normal expenses;
 - due to fair wear and tear;
 - disclosed in this contract; or
 - covered by moneys held in the capital works fund.
- 23.3 Clauses 11, 14.8 and 18.4 do not apply to an obligation of the owners corporation, or to property insurable by it.
- 23.4 Clauses 14.4.2 and 14.6 apply but on a unit entitlement basis instead of an area basis.
- ### • Adjustments and liability for expenses
- 23.5 The *parties* must adjust under clause 14.1 –
- 23.5.1 a regular periodic contribution;
- 23.5.2 a contribution which is not a regular periodic contribution but is disclosed in this contract; and
- 23.5.3 on a unit entitlement basis, any amount paid by the vendor for a normal expense of the owners corporation to the extent the owners corporation has not paid the amount to the vendor.

- 23.6 If a contribution is not a regular periodic contribution and is not disclosed in this contract –
- 23.6.1 the vendor is liable for it if it was determined on or before the contract date, even if it is payable by instalments; and
- 23.6.2 the purchaser is liable for all contributions determined after the contract date.
- 23.7 The vendor must pay or allow to the purchaser on completion the amount of any unpaid contributions for which the vendor is liable under clause 23.6.1.
- 23.8 *Normally*, the purchaser cannot make a claim or *requisition* or *rescind* or *terminate* in respect of –
- 23.8.1 an existing or future actual, contingent or expected expense of the owners corporation;
- 23.8.2 a proportional unit entitlement of the lot or a relevant lot or former lot, apart from a claim under clause 6; or
- 23.8.3 a past or future change in the scheme or a higher scheme.
- 23.9 However, the purchaser can *rescind* if –
- 23.9.1 the special expenses of the owners corporation at the later of the contract date and the creation of the owners corporation when calculated on a unit entitlement basis (and, if more than one lot or a higher scheme is involved, added together), less any contribution paid by the vendor, are more than 1% of the price;
- 23.9.2 in the case of the lot or a relevant lot or former lot in a higher scheme, a proportional unit entitlement for the lot is disclosed in this contract but the lot has a different proportional unit entitlement at the contract date or at any time before completion;
- 23.9.3 a change before the contract date or before completion in the scheme or a higher scheme materially prejudices the purchaser and is not disclosed in this contract; or
- 23.9.4 a resolution is passed by the owners corporation before the contract date or before completion to give to the owners in the scheme for their consideration a strata renewal plan that has not lapsed at the contract date and there is not attached to this contract a strata renewal proposal or the strata renewal plan.
- **Notices, certificates and inspections**
- 23.10 Before completion, the purchaser must *serve* a copy of an interest notice addressed to the owners corporation and signed by the purchaser.
- 23.11 After completion, the purchaser must insert the date of completion in the interest notice and send it to the owners corporation.
- 23.12 The vendor can complete and send the interest notice as agent for the purchaser.
- 23.13 The vendor must *serve* at least 7 days before the date for completion, an information certificate for the lot, the scheme or any higher scheme which relates to a period in which the date for completion falls.
- 23.14 The purchaser does not have to complete earlier than 7 days after *service* of the information certificate and clause 21.3 does not apply to this provision. On completion the purchaser must pay the vendor the prescribed fee for the information certificate.
- 23.15 The vendor authorises the purchaser to apply for the purchaser's own information certificate.
- 23.16 The vendor authorises the purchaser to apply for and make an inspection of any record or other document in the custody or control of the owners corporation or relating to the scheme or any higher scheme.
- **Meetings of the owners corporation**
- 23.17 If a general meeting of the owners corporation is convened before completion –
- 23.17.1 if the vendor receives notice of it, the vendor must immediately notify the purchaser of it; and
- 23.17.2 after the expiry of any cooling off period, the purchaser can require the vendor to appoint the purchaser (or the purchaser's nominee) to exercise any voting rights of the vendor in respect of the lot at the meeting.

24 Tenancies

- 24.1 If a tenant has not made a payment for a period preceding or current at the *adjustment date* –
- 24.1.1 for the purposes of clause 14.2, the amount is to be treated as if it were paid; and
- 24.1.2 the purchaser assigns the debt to the vendor on completion and will if required give a further assignment at the vendor's expense.
- 24.2 If a tenant has paid in advance of the *adjustment date* any periodic payment in addition to rent, it must be adjusted as if it were rent for the period to which it relates.
- 24.3 If the *property* is to be subject to a tenancy on completion or is subject to a tenancy on completion –
- 24.3.1 the vendor authorises the purchaser to have any accounting records relating to the tenancy inspected and audited and to have any other document relating to the tenancy inspected;
- 24.3.2 the vendor must *serve* any information about the tenancy reasonably requested by the purchaser before or after completion; and
- 24.3.3 *normally*, the purchaser can claim compensation (before or after completion) if –
- a disclosure statement required by the Retail Leases Act 1994 was not given when required;
 - such a statement contained information that was materially false or misleading;
 - a provision of the lease is not enforceable because of a non-disclosure in such a statement; or
 - the lease was entered into in contravention of the Retail Leases Act 1994.

- 24.4 If the *property* is subject to a tenancy on completion –
- 24.4.1 the vendor must allow or transfer –
- any remaining bond money or any other security against the tenant's default (to the extent the security is transferable);
 - any money in a fund established under the lease for a purpose and compensation for any money in the fund or interest earned by the fund that has been applied for any other purpose; and
 - any money paid by the tenant for a purpose that has not been applied for that purpose and compensation for any of the money that has been applied for any other purpose;
- 24.4.2 if the security is not transferable, each *party* must do everything reasonable to cause a replacement security to issue for the benefit of the purchaser and the vendor must hold the original security on trust for the benefit of the purchaser until the replacement security issues;
- 24.4.3 the vendor must give to the purchaser –
- at least 2 *business days* before the date for completion, a proper notice of the transfer (an attornment notice) addressed to the tenant, to be held by the purchaser in escrow until completion;
 - any certificate given under the Retail Leases Act 1994 in relation to the tenancy;
 - a copy of any disclosure statement given under the Retail Leases Act 1994;
 - a copy of any document served on the tenant under the lease and written details of its service, if the document concerns the rights of the landlord or the tenant after completion; and
 - any document served by the tenant under the lease and written details of its service, if the document concerns the rights of the landlord or the tenant after completion;
- 24.4.4 the vendor must comply with any obligation to the tenant under the lease, to the extent it is to be complied with by completion; and
- 24.4.5 the purchaser must comply with any obligation to the tenant under the lease, to the extent that the obligation is disclosed in this contract and is to be complied with after completion.
- 25 Qualified title, limited title and old system title**
- 25.1 This clause applies only if the land (or part of it) –
- 25.1.1 is under qualified, limited or old system title; or
- 25.1.2 on completion is to be under one of those titles.
- 25.2 The vendor must *serve* a proper abstract of title *within 7 days* after the contract date.
- 25.3 If an abstract of title or part of an abstract of title is attached to this contract or has been lent by the vendor to the purchaser before the contract date, the abstract or part is *served* on the contract date.
- 25.4 An abstract of title can be or include a list of documents, events and facts arranged (apart from a will or codicil) in date order, if the list in respect of each document –
- 25.4.1 shows its date, general nature, names of parties and any registration number; and
- 25.4.2 has attached a legible photocopy of it or of an official or registration copy of it.
- 25.5 An abstract of title –
- 25.5.1 must start with a good root of title (if the good root of title must be at least 30 years old, this means 30 years old at the contract date);
- 25.5.2 in the case of a leasehold interest, must include an abstract of the lease and any higher lease;
- 25.5.3 *normally*, need not include a Crown grant; and
- 25.5.4 need not include anything evidenced by the Register kept under the Real Property Act 1900.
- 25.6 In the case of land under old system title –
- 25.6.1 in this contract 'transfer' means conveyance;
- 25.6.2 the purchaser does not have to *serve* the transfer until after the vendor has *served* a proper abstract of title; and
- 25.6.3 each vendor must give proper covenants for title as regards that vendor's interest.
- 25.7 In the case of land under limited title but not under qualified title –
- 25.7.1 *normally*, the abstract of title need not include any document which does not show the location, area or dimensions of the land (for example, by including a metes and bounds description or a plan of the land);
- 25.7.2 clause 25.7.1 does not apply to a document which is the good root of title; and
- 25.7.3 the vendor does not have to provide an abstract if this contract contains a delimitation plan (whether in registrable form or not).
- 25.8 On completion the vendor must give the purchaser any *document of title* that relates only to the *property*.
- 25.9 If on completion the vendor has possession or control of a *document of title* that relates also to other property, the vendor must produce it as and where necessary.
- 25.10 The vendor must give a proper covenant to produce where relevant.
- 25.11 The vendor does not have to produce or covenant to produce a document that is not in the possession of the vendor or a mortgagee.
- 25.12 If the vendor is unable to produce an original document in the chain of title, the purchaser will accept a photocopy from the *Land Registry* of the registration copy of that document.

26 Crown purchase money

- 26.1 This clause applies only if purchase money is payable to the Crown, whether or not due for payment.
 26.2 The vendor is liable for the money, except to the extent this contract says the purchaser is liable for it.
 26.3 To the extent the vendor is liable for it, the vendor is liable for any interest until completion.
 26.4 To the extent the purchaser is liable for it, the *parties* must adjust any interest under clause 14.

27 Consent to transfer

- 27.1 This clause applies only if the land (or part of it) cannot be transferred without consent under *legislation* or a *planning agreement*.
 27.2 The purchaser must properly complete and then *serve* the purchaser's part of an application for consent to transfer of the land (or part of it) *within 7 days* after the contract date.
 27.3 The vendor must apply for consent *within 7 days* after *service* of the purchaser's part.
 27.4 If consent is refused, either *party* can *rescind*.
 27.5 If consent is given subject to one or more conditions that will substantially disadvantage a *party*, then that *party* can *rescind within 7 days* after receipt by or *service* upon the *party* of written notice of the conditions.
 27.6 If consent is not given or refused –
 27.6.1 *within 42 days* after the purchaser *serves* the purchaser's part of the application, the purchaser can *rescind*; or
 27.6.2 *within 30 days* after the application is made, either *party* can *rescind*.
 27.7 Each period in clause 27.6 becomes 90 days if the land (or part of it) is –
 27.7.1 under a *planning agreement*; or
 27.7.2 in the Western Division.
 27.8 If the land (or part of it) is described as a lot in an unregistered plan, each time in clause 27.6 becomes the later of the time and 35 days after creation of a separate folio for the lot.
 27.9 The date for completion becomes the later of the date for completion and 14 days after *service* of the notice granting consent to transfer.

28 Unregistered plan

- 28.1 This clause applies only if some of the land is described as a lot in an unregistered plan.
 28.2 The vendor must do everything reasonable to have the plan registered *within 6 months* after the contract date, with or without any minor alteration to the plan or any document to be lodged with the plan validly required or made under *legislation*.
 28.3 If the plan is not registered *within that time* and in that manner –
 28.3.1 the purchaser can *rescind*; and
 28.3.2 the vendor can *rescind*, but only if the vendor has complied with clause 28.2 and with any *legislation* governing the rescission.
 28.4 Either *party* can *serve* notice of the registration of the plan and every relevant lot and plan number.
 28.5 The date for completion becomes the later of the date for completion and 21 days after *service* of the notice.
 28.6 Clauses 28.2 and 28.3 apply to another plan that is to be registered before the plan is registered.

29 Conditional contract

- 29.1 This clause applies only if a provision says this contract or completion is conditional on an event.
 29.2 If the time for the event to happen is not stated, the time is 42 days after the contract date.
 29.3 If this contract says the provision is for the benefit of a *party*, then it benefits only that *party*.
 29.4 If anything is necessary to make the event happen, each *party* must do whatever is reasonably necessary to cause the event to happen.
 29.5 A *party* can *rescind* under this clause only if the *party* has substantially complied with clause 29.4.
 29.6 If the event involves an approval and the approval is given subject to a condition that will substantially disadvantage a *party* who has the benefit of the provision, the *party* can *rescind within 7 days* after either *party* *serves* notice of the condition.
 29.7 If the *parties* can lawfully complete without the event happening –
 29.7.1 if the event does not happen *within the time* for it to happen, a *party* who has the benefit of the provision can *rescind within 7 days* after the end of that time;
 29.7.2 if the event involves an approval and an application for the approval is refused, a *party* who has the benefit of the provision can *rescind within 7 days* after either *party* *serves* notice of the refusal; and
 29.7.3 the date for completion becomes the later of the date for completion and 21 days after the earliest of –
 ● either *party* *serving* notice of the event happening;
 ● every *party* who has the benefit of the provision *serving* notice waiving the provision; or
 ● the end of the time for the event to happen.

- 29.8 If the *parties* cannot lawfully complete without the event happening –
- 29.8.1 if the event does not happen *within* the time for it to happen, either *party* can *rescind*;
- 29.8.2 if the event involves an approval and an application for the approval is refused, either *party* can *rescind*;
- 29.8.3 the date for completion becomes the later of the date for completion and 21 days after either *party* serves notice of the event happening.
- 29.9 A *party* cannot *rescind* under clauses 29.7 or 29.8 after the event happens.

30 Manual transaction

- 30.1 This clause applies if this transaction is to be conducted as a *manual transaction*.
- **Transfer**
- 30.2 *Normally*, the purchaser must *serve* the transfer at least 7 days before the date for completion.
- 30.3 If any information needed for the transfer is not disclosed in this contract, the vendor must *serve* it.
- 30.4 If the purchaser *serves* a transfer and the transferee is not the purchaser, the purchaser must give the vendor a direction signed by the purchaser personally for that transfer.
- 30.5 The vendor can require the purchaser to include a covenant or easement in the transfer only if this contract contains the wording of the proposed covenant or easement, and a description of the land burdened and benefited.
- **Place for completion**
- 30.6 *Normally*, the *parties* must complete at the completion address, which is –
- 30.6.1 if a special completion address is stated in this contract - that address; or
- 30.6.2 if none is stated, but a first mortgagee is disclosed in this contract and the mortgagee would usually discharge the mortgage at a particular place - that place; or
- 30.6.3 in any other case - the vendor's *solicitor's* address stated in this contract.
- 30.7 The vendor by reasonable notice can require completion at another place, if it is in NSW, but the vendor must pay the purchaser's additional expenses, including any agency or mortgagee fee.
- 30.8 If the purchaser requests completion at a place that is not the completion address, and the vendor agrees, the purchaser must pay the vendor's additional expenses, including any agency or mortgagee fee.
- **Payments on completion**
- 30.9 On completion the purchaser must pay to the vendor the amounts referred to in clauses 16.5.1 and 16.5.2, by cash (up to \$2,000) or *settlement cheque*.
- 30.10 *Normally*, the vendor can direct the purchaser to produce a *settlement cheque* on completion to pay an amount adjustable under this contract and if so –
- 30.10.1 the amount is to be treated as if it were paid; and
- 30.10.2 the *cheque* must be forwarded to the payee immediately after completion (by the purchaser if the *cheque* relates only to the *property* or by the vendor in any other case).
- 30.11 If the vendor requires more than 5 *settlement cheques*, the vendor must pay \$10 for each extra *cheque*.
- 30.12 If the purchaser must make a *GSTRW payment* the purchaser must –
- 30.12.1 produce on completion a *settlement cheque* for the *GSTRW payment* payable to the Deputy Commissioner of Taxation;
- 30.12.2 forward the *settlement cheque* to the payee immediately after completion; and
- 30.12.3 *serve* evidence of receipt of payment of the *GSTRW payment* and a copy of the settlement date confirmation form submitted to the Australian Taxation Office.
- 30.13 If the purchaser must pay an *FRCGW remittance*, the purchaser must –
- 30.13.1 produce on completion a *settlement cheque* for the *FRCGW remittance* payable to the Deputy Commissioner of Taxation;
- 30.13.2 forward the *settlement cheque* to the payee immediately after completion; and
- 30.13.3 *serve* evidence of receipt of payment of the *FRCGW remittance*.

31 Foreign Resident Capital Gains Withholding

- 31.1 This clause applies only if –
- 31.1.1 the sale is not an excluded transaction within the meaning of s14-215 of Schedule 1 to the *TA Act*; and
- 31.1.2 a *clearance certificate* in respect of every vendor is not attached to this contract.
- 31.2 If the vendor *serves* any *clearance certificate* or *variation*, the purchaser does not have to complete earlier than 5 *business days* after that *service* and clause 21.3 does not apply to this provision.
- 31.3 The purchaser must at least 2 *business days* before the date for completion, *serve* evidence of submission of a purchaser payment notification to the Australian Taxation Office by the purchaser or, if a direction under either clause 4.8 or clause 30.4 has been given, by the transferee named in the transfer the subject of that direction.
- 31.4 The vendor cannot refuse to complete if the purchaser complies with clause 31.3 and, as applicable, clauses 4.10 or 30.13.
- 31.5 If the vendor *serves* in respect of every vendor either a *clearance certificate* or a *variation* to 0.00 percent, clauses 31.3 and 31.4 do not apply.

32 Residential off the plan contract

- 32.1 This clause applies if this contract is an off the plan contract within the meaning of Division 10 of Part 4 of the Conveyancing Act 1919 (the Division).
- 32.2 No provision of this contract has the effect of excluding, modifying or restricting the operation of the Division.
- 32.3 If the purchaser makes a claim for compensation under the terms prescribed by sections 4 to 6 of Schedule 3 to the Conveyancing (Sale of Land) Regulation 2022 –
- 32.3.1 the purchaser cannot make a claim under this contract about the same subject matter, including a claim under clauses 6 or 7; and
 - 32.3.2 the claim for compensation is not a claim under this contract.

12/23 PACIFIC PDE DEE WHY NSW 2099

CONDITIONS OF SALE BY AUCTION

If the property is or is intended to be sold at auction:

Bidders Record means the Bidders Record to be kept pursuant to Clause 18 of the *Property, Stock and Business Agents Regulation 2003* and Section 68 of the *Property, Stock and Business Agents Act 2002*:

- (1) The following conditions are prescribed as applicable to and in respect of the sale by auction of land or livestock:
 - (a) The principal's reserve price must be given in writing to the auctioneer before the auction commences.
 - (b) A bid for the seller cannot be made unless the auctioneer has, before the commencement of the auction, announced clearly and precisely the number of bids that may be made by or on behalf of the seller.
 - (c) The highest bidder is the purchaser, subject to any reserve price.
 - (d) In the event of a disputed bid, the auctioneer is the sole arbitrator and the auctioneer's decision is final.
 - (e) The auctioneer may refuse to accept any bid that, in the auctioneer's opinion, is not in the best interests of the seller.
 - (f) A bidder is taken to be a principal unless, before bidding, the bidder has given to the auctioneer a copy of a written authority to bid for or on behalf of another person.
 - (g) A bid cannot be made or accepted after the fall of the hammer.
 - (h) As soon as practicable after the fall of the hammer the purchaser is to sign the agreement (if any) for sale.
- (2) The following conditions, in addition to those prescribed by subclause (1), are prescribed as applicable to and in respect of the sale by auction of residential property or rural land:
 - (a) All bidders must be registered in the Bidders Record and display an identifying number when making a bid.
 - (b) Subject to subclause (2A), the auctioneer may make only one vendor bid at an auction for the sale of residential property or rural land and no other vendor bid may be made by the auctioneer or any other person.

- (c) Immediately before making a vendor bid the auctioneer must announce that the bid is made on behalf of the seller or announce "vendor bid".
- (2A) The following conditions, in addition to those prescribed by subclauses (1) and (2), are prescribed as applicable to and in respect of the sale by auction of co-owned residential property or rural land or the sale of such land by a seller as executor or administrator:
- (a) More than one vendor bid may be made to purchase the interest of a co-owner.
 - (b) A bid by or on behalf of an executor or administrator may be made to purchase in that capacity.
 - (c) Before the commencement of the auction, the auctioneer must announce that bids to purchase the interest of another co-owner or to purchase as executor or administrator may be made by or on behalf of the seller.
 - (d) Before the commencement of the auction, the auctioneer must announce the bidder registration number of any co-owner, executor or administrator or any person registered to bid on behalf of any co-owner, executor or administrator.
- (3) The following condition, in addition to those prescribed by subclause (1), is prescribed as applicable to and in respect of the sale by auction of livestock:

The purchaser of livestock must pay the stock and station agent who conducted the auction (or under whose immediate and direct supervision the auction was conducted) or the vendor the full amount of the purchase price:

- (a) if that amount can reasonably be determined immediately after the fall of the hammer – before the close of the next business day following the auction, or
- (b) if that amount cannot reasonably be determined immediately after the fall of the hammer – before the close of the next business day following determination of that amount,

unless some other time for payment is specified in a written agreement between the purchaser and the agent or the purchaser and the vendor made before the fall of the hammer.

Special Conditions Annexed to Contract for the Sale of Land – 2022 Edition

33. Amendments to This Contract

33.1 Clause 1 - Clause 1 - the definition of bank - delete the words “a building society or a credit union”.

33.2 Clause 7.1.1- replace “5%” with “1%”.

33.3 Clause 8.1.1- delete the words “on reasonable ground”.

33.4 Clause 8.2.2 – delete.

33.5 Clause 10 – add the following clause: “10.4 The vendor discloses all the information appearing in the copy documents annexed to this contract even if the contract does not otherwise refer to that information.”

33.6 Clause 12.2 – delete.

33.7 Clause 14.4 replace the first sentence with “The parties must adjust any land tax, including surcharge land tax (as defined in the Land Tax Act 1956), for the year current at the *adjustment date* –”

33.8 Clause 15 – insert words “4:00pm on” after the words “must complete by”.

33.9 Clause 23.6.1 – delete “even if it is payable by instalments” and replace by “but if it is payable by instalment, only the instalment payable prior to the date of this contract”.

33.10 Clause 23.14 – delete.

33.11 Clause 24.4.2 – add “however the vendor shall not be required to call upon any security against a tenant’s default arising after completion” at the end of the clause.

33.12 Clause 24.3.3 – delete.

33.13 Clause 29 – delete.

33.14 Clause 31.1 - add the following clause:

“31.1.3 A clearance certificate or variation notice in respect of every vendor shall be provided by the vendor to the purchaser on the following conditions:

- a) within 28 calendar days after the exchange of this contract if the completion date is more than 35 days after the date for exchange; or
- b) 2 Business days prior to the date for completion if the completion date is equal to or less than 35 days after the date for exchange.”

33.15 Delete the words “at least 2 business days” in clause 31.3.

33.16 Clause 31.2 – amend “5 business days” as “2 business days”.

33.17 Add the following clause:

“31.6 If the vendor serves in respect of any or each vendor any variation, the settlement cheque for the remittance amount payable to the Deputy Commission of Taxation produced on completion must be equivalent to the varied foreign resident capital gains withholding rate in the variation notice.”

34. Inspection by Purchaser

The property and any furnishings or chattels referred to in this Contract are sold in its present conditions and state of repair subject to all defects (latent or patent) infestation and dilapidation and all damage wear and tear pending completion. The Purchaser may not make a claim or requisition, delay completion, rescind or terminate in respect of a defect in or any lack of repair of the improvements (or any part of the improvements), furnishings or chattels.

35. Representations, Warranties and Acknowledgments

The Purchaser enters into this Contract entirely as a result of the Purchaser's own enquiries and the Purchaser warrants to the Vendor that it has not nor has anyone on the Vendor's behalf made any representation other than as set out in this Contract which has in any manner influenced the Purchaser to enter into this Contract. The Purchaser does not rely on any representation letter document correspondence or arrangement whether oral or in writing as adding to or amending the terms conditions warranties and arrangements set out in this Contract.

36. Investment of Deposit

Further to Clause 2.9 the Vendor and the Purchaser acknowledge that each is aware of the provisions of the taxation laws relating to tax file numbers and in particular that if a tax file number or claim for exemption is not quoted to an investment body, it will deduct tax from the unattributed income. Unattributed income is income from an investment for which the investor has not quoted a tax file number or informed the investment body that the investor is exempt from quoting the investor's tax file number.

37. Release of Deposit

The Purchaser agrees to release to the Vendor the whole or part of the deposit for use by the Vendor as a deposit, stamp duty of the purchase or on settlement of another property.

The Vendor warrants that such deposit will be paid only to the trust account of a real estate agent, solicitor or licensed conveyancer and shall not be further released without the written consent of the Purchaser.

38. Requisitions on Title

The Purchaser acknowledges that the only form of general requisitions on title that the Purchaser shall be entitled to raise pursuant to Clause 5 shall be in the form of Requisitions on Title annexed hereto as **Annexure "A"**.

39. Provision on Death, Mental Illness, Liquidation

Without in any manner negating, limiting or restricting any rights or remedies which would have been available to either party hereto at law or in equity had this special condition not been included, it is agreed and declared that:

- (a) if any party (being a Company) prior to completion resolves to go into liquidation or have a summons for the winding up of the party presented (and

not withdrawn within fourteen (14) days of presentation) or enters into any scheme or arrangement with its creditors under Part 5.1 of the Corporations Act or any similar legislation or should any liquidator, receiver or official manager be appointed in respect of the party, then in any of such events that party shall be deemed to be in default; and

- (b) if the Vendor (or one of them if there is more than one individual) or Purchaser (or one of them if there is more than one individual) prior to completion dies or becomes mentally ill or a mentally disordered person in accordance with the relevant criteria set out in Chapter 3 of the Mental Health Act, 1990 then the other party may by written notice to the first-mentioned party rescind this Contract in which event the provisions of Clause 19 shall apply.

40. Purchaser Warranty on Agent

The Purchaser warrants that they were not introduced to the Vendor of the property by any real estate agent except the agent (if any) named in this Contract and the Purchaser indemnifies the Vendor against any claim for commission which might be made by any agent resulting from an introduction forming a breach of such warranty and against all costs and expenses incidental to defending any such claim.

It is agreed that these indemnities shall be continuing indemnities not merging on completion.

41. Caveat or Mortgage

The Purchaser shall not be entitled to require the Vendor prior to completion to register a Discharge of any Mortgage or Charge or Withdrawal of any Caveat affecting the subject land. If at the date of completion of this Contract there is noted on any Certificate of Title in respect of the property or any part thereof any Mortgage, Charge or Caveat, the Purchaser will accept a Discharge or Withdrawal thereof so far as the same relates to the property.

42. Interest for Late Completion

If the Purchaser does not complete this purchase on or before the date specified by this Contract or the date nominated by the Vendor after the completion date, otherwise than as a result of any default by the Vendor, the Purchaser shall pay interest at the rate of 8% per annum on the balance of the purchase price from the due date for completion until the date completion actually takes place.

43. Notice to Complete

Should any event arise entitling the Vendor to issue a Notice to Complete on the Purchaser, then the Vendor may serve such a Notice on the Purchaser requiring the Purchaser to complete this Contract within a period of fourteen (14) days from the service of such notice making time of the essence of this Contract. The Parties agree that such a period of time is both reasonable and proper.

On completion, the default Purchaser must pay a fee of \$385.00 to the Vendor's Solicitor being the cost for issuing such Notice to Complete to the Purchaser.

44. FIRB Approval

The Purchaser warrants it does not require the consent of the Foreign Investment Review Board (“FIRB”) to the purchase of the property and in the event, notwithstanding this warranty, that any fine or penalty is incurred by the Vendor for the purchaser’s noncompliance to the Foreign Acquisitions and Takeovers Act 1975 relating to the foreign acquisition of certain land interests and to foreign control of certain business enterprises and mineral rights, then the Purchaser shall indemnify and keep indemnified the Vendor against such fine or penalty.

It is agreed that these indemnities shall be continuing indemnities not merging on completion.

45. Deposit by Bond or Guarantee

If the 10% deposit or part of the deposit paid by bond or guarantee:

- (c) Notwithstanding the provision of Clause 2, the Vendor agrees to accept in lieu of payment of the whole or part of the deposit, a bond or guarantee for the amount of the deposit in and to the effect of the form annexed hereto;
- (d) The Purchaser must pay to the Vendor the amount stipulated in the bond or guarantee in cash or by unendorsed bank cheque on completion or at such other time as may be provided for the deposit to be accounted for the Vendor; or
- (e) If the Vendor serves on the Purchaser written notice claiming forfeiture of the deposit, then to the extent that the deposit has not already been paid by the issuer of the bond or guarantee, the Purchaser must forthwith pay the deposit (or so much as has not been paid pursuant to the bond or guarantee) to the deposit holder.

46. Where Deposit is Less Than 10%

In the event that the Purchaser pays less than ten percent (10%) of the purchase price as deposit, if the Purchaser commits a default that entitles the Vendor to terminate this Contract, the whole of the 10% deposit shall become due and payable to the Vendor notwithstanding that this Contract is not completed.

This clause shall not merge on completion. The Vendor shall be entitled to sue the Purchaser for recovery of the 10% deposit that remains outstanding as a debt due by the Purchaser to the Vendor.

47. Reasonable Cost for Re-arrangement of Settlement

If settlement of this matter does not take place at the first scheduled time due to the default of the Purchaser, or his/her mortgagee, then the Purchaser shall pay all fees including, agency fees (\$55.00), re-certification fees incurred by the Vendor, or his/her mortgagee, in relation to any re-arrangement of settlement.

48. Company Director Acting as a Guarantor

In the event that the purchaser being a company each of the persons signing this Contract on behalf of the company warrants that the company has been duly incorporated and

those people acknowledge and agree that they shall be personally liable under this Contract, both jointly and severally, as if they had been named as purchasers. In the event that the Purchaser defaults in its obligation under this Contract, the directors of that company who have signed this Contract on behalf of the company hereby guarantee, both jointly and severally, the due performance of the company in relation to its obligations pursuant to the terms of this Contract in every respect as if they had personally entered into this Contract themselves. The provisions of this special condition shall not merge upon completion or termination of this Contract.

Upon the exchange of this Contract, the directors signing this Contract on behalf of the company agree to complete and hand over a duly signed Company Directors Guarantee in the form attached in this Contract. The Purchaser agrees that the Purchaser has breached an essential term of this Contract if the Company Directors Guarantee is not provided to the Vendor upon exchange and that the Vendor is entitled to terminate this Contract in accordance with Clause 9, unless the duly signed Company Directors Guarantee is served on the Vendor prior to the date of the Vendor's notice of termination.

49. Swimming Pool Compliance Certificate

If there is a swimming pool on the property, the Purchaser acknowledges that the property is sold without a swimming pool compliance certificate and the Purchaser shall make no objection, requisition, claim or delay the settlement in respect of the swimming pool or the pool enclosure, nor shall the Purchaser be entitled to rescind or terminate this Contract, notwithstanding any other provision of this Contract.

50. Sewer Diagrams

The Vendor discloses that the sewerage service diagram or location diagram issued by the water authority enclosed in this Contract is, as far as the vendor is aware, the current sewer diagram. The Vendor does not warrant or make any representation as to the accuracy or completeness of the diagram and the Purchaser shall not be entitled to make any objection, requisition or claim for compensation in respect of any matter or thing disclosed therein or arising wherefrom or because of the lack of accuracy or completeness thereof.

51. Survey Report or Building Certificate

If this Contract contains a copy of survey report and/or building certificate on the property, the Vendor is not obliged to produce the original survey report and/or building certificate on completion. In addition, the Vendor does not warrant the accuracy or completeness of the report and/or certificate.

If this Contract does not contain a survey report and/or building certificate of the property, the Vendor shall not be required to apply for, carry out any works or do anything else necessary for the issue of the report and/or certificate.

If the local council refuses or fails to issue the building certificate, that refusal or failure or the facts upon which such refusal or failure is based will not be a defect of the title of the property and the Purchaser must take the title despite the council's refusal or failure or the facts.

If the local council requires work to be done on the property as a condition of issuing a building certificate, or issue a building certificate but requires work to be carried out, the Purchaser must not make any claim against the Vendor, delay completion or terminate this Contract because of the council's requirement to carry out that work.

52. Tenancies and Adjustment of Rent

If the property is sold subject to any tenancies:

- (a) The Vendor does not warrant that the tenant will continue to remain on the property after exchange;
- (b) If the Lease has expired and the Purchaser requires vacant possession, the Purchaser must advise the Vendor in writing, within 3 business days after the date of this Contract, time is essential; then
- (c) The Vendor will use his/her best endeavors to have the tenant vacate the property by the completion date, however the Purchaser must accept the tenancy on completion if the vacant possession is not obtained after the Vendor exhausts his/her efforts to do so;
- (d) If the Purchaser does not give the above notice to the Vendor, then the Purchaser must accept the tenancy on completion; however
- (e) If the tenant vacates the property before completion, irrespective of whether or not the lease has expired, the Purchaser must accept the vacant possession on completion.

The Purchaser cannot make any claim, objection or requisition, rescind or terminate this Contract, or delay completion in respect of any of these matters.

The Vendor shall on completion complete any repairs and maintenance raised or notified by the tenant prior to the exchange of this Contract. The repairs and maintenance under this clause are pursuant to the landlord's obligations within the attached lease.

53. Purchaser's Finance

The Purchaser agrees and acknowledges that it must satisfy itself as to its own financial status in completing this Contract before entering into this Contract. The Purchaser is not entitled to terminate this Contract in the event that the Purchaser is unable to obtain sufficient funds in completing this Contract.

54. Adjustments

The Vendor and the Purchaser agrees to adjust all usual outgoings and all amounts under this Contract on settlement; however, if any amount is incorrectly calculated, overlooked or an error is made in such calculations then the Vendor and the Purchaser agree to correct such error and to reimburse each other accordingly within 5 business days of written notification from either party. The provisions of this special condition shall not merge upon completion of this Contract.

55. Christmas Closure Period

55.1 Notwithstanding any provision of this Contract to the contrary, where the Completion Date falls in the period between Friday, 23 December 2022 to Tuesday, 10 January 2023, both dates inclusive ("Christmas Closure Period"), then the Completion Date is deemed to be extended to Wednesday, 11 January 2023.

55.2 If:

- a) the Completion Date falls on a date prior to the first day of the Christmas Closure Period; and
- b) completion does not occur on the Completion Date; and
- c) the delay in completion is not due to the fault or default of the Vendor;
- d) then interest for the Christmas Closure Period will be payable by the Purchaser in addition to interest payable in respect of any other period in accordance with Clause 42.

55.3 Notwithstanding Clause 15 of this Contract, neither party will be entitled to:

- a) serve a notice to complete during the Christmas Closure Period; or
- b) serve a notice to complete which requires completion to occur during the Christmas Closure Period.

Company Directors Guarantee

We, _____ and _____ (the “GUARANTORS”), being the directors of the Purchaser being _____ (ACN _____), a company duly incorporated and having its registered office at _____, in consideration of the Vendor at our request to sell the property to the Purchaser DO HEREBY GUARANTEE to the Vendor the due and punctual performance by the Purchaser of all the clauses and conditions of this Contract and do further COVENANT AND AGREE THAT we will indemnify and keep indemnify the Vendor against any loss and/or damage howsoever arising which the Vendor may suffer as a consequence of any failure or breach of the Purchaser to perform its obligation under this Contract.

The Guarantors acknowledge that the abovesaid guarantees and covenants are personal, both jointly and severally. The Guarantors further acknowledge that they have read and understood the clauses and conditions of this Contract in its entirety as evidenced by their signature hereto.

Signed sealed and delivered by the Guarantor
_____ in the presence of:

Signature of the Guarantor:

Signature of Witness

Print Name:

Print Name of Witness

Signed sealed and delivered by the Guarantor
_____ in the presence of:

Signature of the Guarantor:

Signature of Witness

Print Name:

Print Name of Witness

STRATA TITLE (RESIDENTIAL) PROPERTY REQUISITIONS ON TITLE

Vendor:
Purchaser:
Property: Unit
Dated:

Possession and tenancies

1. Vacant possession of the Property must be given on completion unless the Contract provides otherwise.
2. Is anyone in adverse possession of the Property or any part of it?
3.
 - (a) What are the nature and provisions of any tenancy or occupancy?
 - (b) If they are in writing, all relevant documentation should be produced, found in order and handed over on completion with notices of attornment.
 - (c) Please specify any existing breaches.
 - (d) All rent should be paid up to or beyond the date of completion.
 - (e) Please provide details of any bond together with the Rental Bond Board's reference number.
 - (f) If any bond money is held by the Rental Bond Board, the appropriate transfer documentation duly signed should be handed over on completion.
4. Is the Property affected by a protected tenancy (tenancy affected by Parts 2, 3, 4 or 5 of the *Landlord and Tenant (Amendment) Act 1948 (NSW)*)? If so, please provide details.
5. If the tenancy is subject to the *Residential Tenancies Act 2010 (NSW)*:
 - (a) has either the vendor or any predecessor or the tenant applied to the NSW Civil and Administrative Tribunal for an order?
 - (b) have any orders been made by the NSW Civil and Administrative Tribunal? If so, please provide details.

Title

6. Subject to the Contract, on completion the vendor should be registered as proprietor in fee simple of the Property free from all encumbrances and notations and recorded as the owner of the Property on the strata roll, free from all other interests.
7. On or before completion, any mortgage, caveat, writ or priority notice must be discharged, withdrawn, cancelled or removed as the case may be or, in the case of a mortgage, caveat or priority notice, an executed discharge or withdrawal or removal handed over on completion together with a notice under Section 22 of the *Strata Schemes Management Act 2015 (NSW) (Act)*.
8. Are there any proceedings pending or concluded that could result in the recording of any writ on the title to the Property or in the General Register of Deeds? If so, full details should be provided at least 14 days prior to completion.
9. When and where may the title documents be inspected?
10. Are any chattels or fixtures subject to any hiring or leasing agreement or charge or to any security interest under the *Personal Properties Securities Act 2009 (Cth)*? If so, details must be given and all indebtedness cleared and title transferred unencumbered to the vendor prior to completion.

Adjustments

11. All outgoings referred to in clause 14.1 of the Contract must be paid up to and including the date of completion.
12. Is the vendor liable to pay land tax or is the Property otherwise charged or liable to be charged with land tax? If so:
 - (a) to what year has a return been made?
 - (b) what is the taxable value of the Property for land tax purposes for the current year?
13. The vendor must serve on the purchaser a current land tax certificate (issued under Section 47 of the *Land Tax Management Act 1956 (NSW)*) at least 14 days before completion.

Survey and building

14. Subject to the Contract, survey should be satisfactory and show that the whole of the Property and the common property is available, that there are no encroachments by or upon the Property or the common property.
15. Is the vendor in possession of a survey report? If so, please produce a copy for inspection prior to completion. The original should be handed over on completion.
16. In respect of the Property and the common property:
 - (a) Have the provisions of the *Local Government Act (NSW)*, the *Environmental Planning and Assessment Act 1979 (NSW)* and their regulations been complied with?
 - (b) Is there any matter that could justify the making of an upgrading or demolition order in respect of any building or structure?

- (c) Has the vendor a Building Certificate which relates to all current buildings or structures on the Property? If so, it should be handed over on completion. Please provide a copy in advance.
 - (d) Has the vendor a Final Occupation Certificate issued under the *Environmental Planning and Assessment Act 1979* for all current buildings or structures on the Property? If so, it should be handed over on completion. Please provide a copy in advance.
 - (e) In respect of any residential building work carried out in the last 7 years:
 - (i) please identify the building work carried out;
 - (ii) when was the building work completed?
 - (iii) please state the builder's name and licence number;
 - (iv) please provide details of insurance under the *Home Building Act 1989 (NSW)*.
 - (f) Are there any proposals by the Owners Corporation or an owner of a lot to make any additions or alterations or to erect any new structures on the common property? If so, please provide details.
 - (g) Has any work been carried out by the vendor on the Property or the common property? If so:
 - (i) has the work been carried out in accordance with the by-laws and all necessary approvals and consents?
 - (ii) does the vendor have any continuing obligations in relation to the common property affected?
17. Is the vendor aware of any proposals to:
- (a) resume the whole or any part of the Property or the common property?
 - (b) carry out building alterations to an adjoining lot which may affect the boundary of that lot or the Property?
 - (c) deal with, acquire, transfer, lease or dedicate any of the common property?
 - (d) dispose of or otherwise deal with any lot vested in the Owners Corporation?
 - (e) create, vary or extinguish any easements, restrictions or positive covenants over the Property or the common property?
 - (f) subdivide or consolidate any lots and/or any common property or to convert any lots into common property?
 - (g) grant any licence to any person, entity or authority (including the Council) to use the whole or any part of the common property?
18. Has the vendor (or any predecessor) or the Owners Corporation entered into any agreement with or granted any indemnity to the Council or any other authority concerning any development on the Property or the common property?
19. In relation to any swimming pool on the Property or the common property:
- (a) did its installation or construction commence before or after 1 August 1990?
 - (b) has the swimming pool been installed or constructed in accordance with approvals under the *Local Government Act 1919 (NSW)* and *Local Government Act 1993 (NSW)*?
 - (c) does it comply with the provisions of the *Swimming Pools Act 1992 (NSW)* and regulations relating to access? If not, please provide details of the exemptions claimed;
 - (d) have any notices or orders issued or been threatened under the *Swimming Pools Act 1992 (NSW)* or regulations?
 - (e) if a certificate of non-compliance has issued, please provide reasons for its issue if not disclosed in the contract;
 - (f) originals of certificate of compliance or non-compliance and occupation certificate should be handed over on settlement.
- 20.
- (a) Is the vendor aware of any dispute regarding boundary or dividing fences in the strata scheme?
 - (b) Is the vendor aware of any notice, claim or proceedings under the *Dividing Fences Act 1991 (NSW)* or the *Encroachment of Buildings Act 1922 (NSW)* affecting the strata scheme?

Affectations, notices and claims

21. In respect of the Property and the common property:
- (a) Is the vendor aware of any rights, licences, easements, covenants or restrictions as to use of them other than those disclosed in the Contract?
 - (b) Has any claim been made by any person to close, obstruct or limit access to or from them or to prevent the enjoyment of any easement appurtenant to them?
 - (c) Is the vendor aware of:
 - (i) any road, drain, sewer or storm water channel which intersects or runs through them?
 - (ii) any dedication to or use by the public of any right of way or other easement over any part of them?
 - (iii) any latent defects in them?
 - (d) Has the vendor any notice or knowledge of them being affected by the following:
 - (i) any notice requiring work to be done or money to be spent on them or any footpath or road adjoining? If so, such notice must be complied with prior to completion.
 - (ii) any work done or intended to be done on them or the adjacent street which may create a charge on them or the cost of which might be or become recoverable from the purchaser?
 - (iii) any sum due to any local or public authority recoverable from the purchaser? If so, it must be paid prior to completion.
 - (iv) any realignment or proposed realignment of any road adjoining them?

- (v) any contamination including, but not limited to, materials or substances dangerous to health such as asbestos and fibreglass?

Applications, Orders etc

22. Are there any applications made, proposed or threatened, whether by an owner of a lot or the Owners Corporation, to the NSW Civil and Administrative Tribunal, any Court or to the Registrar General for orders relating to the strata scheme, the Property or the common property (including orders to vary the strata scheme consequent upon damage or destruction or to terminate the strata scheme) which are yet to be determined? If so, please provide particulars.
23. Are there any mediations currently being conducted by the Commissioner of Fair Trading, Department of Finance Services and Innovation in relation to the Property or the common property which involve the vendor or the Owners Corporation? If so, please provide particulars.
24. Are there any:
- (a) orders of the Tribunal;
 - (b) notices of or investigations by the Owners Corporation;
 - (c) notices or orders issued by any Court; or
 - (d) notices or orders issued by the Council or any public authority or water authority, affecting the Property or the common property not yet complied with? In so far as they impose an obligation on the vendor they should be complied with by the vendor before completion.
25. Have any orders been made by any Court or Tribunal that money (including costs) payable by the Owners Corporation be paid from contributions levied in relation to the Property? If so, please provide particulars.
26. Has the vendor made any complaints or been the subject of any complaints arising out of noise affecting the Property or emanating from the Property?
27. Has any proposal been given by any person or entity to the Owners Corporation for:
- (a) a collective sale of the strata scheme; or
 - (b) a redevelopment of the strata scheme?
- If so, please provide particulars of the proposal and the steps taken and decisions made in relation to the proposal to the present time.

Owners Corporation management

28. Has the initial period expired?
29. Are any actions proposed to be taken or have any been taken by the Owners Corporation in the initial period which would be in breach of its powers without an order authorising them?
30. If the Property includes a utility lot, please specify the restrictions.
31. Do any special expenses (as defined in clause 23.2 of the Contract, including any liabilities of the Owners Corporation) exceed 1% of the price?
32. Has an appointment of a strata managing agent and/or a building manager been made? If so:
- (a) who has been appointed to each role;
 - (b) when does the term or each appointment expire; and
 - (c) what functions have been delegated to the strata managing agent and/or the building manager.
33. Has the Owners Corporation entered into any agreement to provide amenities or services to the Property? If so, please provide particulars.
34. Has a resolution been passed for the distribution of surplus money from the administrative fund or the capital works fund? If so, please provide particulars.
35. Have the by-laws adopted a common property memorandum as prescribed by the regulations for the purposes of Section 107 of the Act? If so, has the memorandum been modified? Please provide particulars.
36. Is there a registered building management statement pursuant to Section 108 of the *Strata Schemes Development Act 2015 (NSW)*? If so, are there any proposals to amend the registered building management statement?
37. If the strata scheme was in existence at 30 November 2016, has the Owners Corporation taken steps to review the by-laws that were current at that date? If so, please provide particulars.
38. Are there any pending proposals to amend or repeal the current by-laws or to add to them?
39. Are there any proposals, policies or by-laws in relation to the conferral of common property rights or which deal with short term licences and/or holiday lettings?
40. If not attached to the Contract, a strata information certificate under Section 184 of the Act should be served on the purchaser at least 7 days prior to completion.
41. Has the Owners Corporation met all of its obligations under the Act relating to:
- (a) insurances;
 - (b) fire safety;
 - (c) occupational health and safety;
 - (d) building defects and rectification in relation to any applicable warranties under the *Home Building Act 1989 (NSW)*;
 - (e) the preparation and review of the 10 year plan for the capital works fund; and
 - (f) repair and maintenance.
42. Is the secretary of the Owners Corporation in receipt of a building bond for any building work on a building that is part of the Property or the common property?
43. Has an internal dispute resolution process been established? If so, what are its terms?
44. Has the Owners Corporation complied with its obligation to lodge tax returns with the Australian Taxation Office and has all tax liability been paid?

Capacity

45. If the Contract discloses that the vendor is a trustee, evidence should be produced to establish the trustee's power of sale.

Requisitions and transfer

46. If not attached to the Contract and the transaction is not an excluded transaction, any *clearance certificate* under Section 14-220 of Schedule 1 of the *Taxation Administration Act 1953 (Cth)* should be served on the purchaser at least 7 days prior to completion.
47. If the transfer or any other document to be handed over on completion is executed pursuant to a power of attorney, then at least 7 days prior to completion a copy of the registered power of attorney should be produced and found in order.
48. If the vendor has or is entitled to have possession of the title deeds the Certificate Authentication Code must be provided 7 days prior to settlement.
49. Searches, surveys, enquiries and inspection of title deeds must prove satisfactory.
50. The purchaser reserves the right to make further requisitions prior to completion.
51. Unless we are advised by you to the contrary prior to completion, it will be assumed that your replies to these requisitions remain unchanged as at the completion date.



FOLIO: 12/SP95882

SEARCH DATE	TIME	EDITION NO	DATE
-----	----	-----	----
9/11/2022	4:27 PM	4	27/10/2020

LAND

LOT 12 IN STRATA PLAN 95882
AT DEE WHY
LOCAL GOVERNMENT AREA NORTHERN BEACHES

FIRST SCHEDULE

SI XIN YUAN (T AM973235)

SECOND SCHEDULE (2 NOTIFICATIONS)

- 1 INTERESTS RECORDED ON REGISTER FOLIO CP/SP95882
- 2 AQ505979 MORTGAGE TO AUSTRALIA AND NEW ZEALAND BANKING GROUP LIMITED

NOTATIONS

UNREGISTERED DEALINGS: NIL

*** END OF SEARCH ***



FOLIO: CP/SP95882

SEARCH DATE	TIME	EDITION NO	DATE
-----	----	-----	----
9/11/2022	4:27 PM	3	17/6/2021

LAND

THE COMMON PROPERTY IN THE STRATA SCHEME BASED ON STRATA PLAN 95882
WITHIN THE PARCEL SHOWN IN THE TITLE DIAGRAM

AT DEE WHY
LOCAL GOVERNMENT AREA NORTHERN BEACHES
PARISH OF MANLY COVE COUNTY OF CUMBERLAND
TITLE DIAGRAM SP95882

FIRST SCHEDULE

THE OWNERS - STRATA PLAN NO. 95882
ADDRESS FOR SERVICE OF DOCUMENTS:
C/- ROBINSON STRATA MANAGEMENT PTY LTD
PO BOX 280
FRESHWATER NSW 2096

SECOND SCHEDULE (12 NOTIFICATIONS)

- 1 RESERVATIONS AND CONDITIONS IN THE CROWN GRANT(S)
- 2 DP1201083 RIGHT OF CARRIAGEWAY 3 METRE(S) WIDE AND VARIABLE
WIDTH AFFECTING THE PART(S) SHOWN SO BURDENED IN THE
TITLE DIAGRAM
- 3 DP1201083 RIGHT OF ACCESS 6 METRE(S) WIDE APPURTENANT TO THE
LAND ABOVE DESCRIBED
- 4 DP1207001 EASEMENT TO DRAIN WATER 1 METRE(S) WIDE AFFECTING THE
PART(S) SHOWN SO BURDENED IN THE TITLE DIAGRAM
- 5 DP1222206 RIGHT OF CARRIAGEWAY 3 METRE(S) WIDE AND VARIABLE
WIDTH APPURTENANT TO THE LAND ABOVE DESCRIBED
- 6 AK630238 EASEMENT FOR SERVICES 1 & 3.7 WIDE APPURTENANT TO
THE LAND ABOVE DESCRIBED AFFECTING THE SITE SHOWN IN
PLAN WITH AK630238
- 7 AM709465 RESTRICTION(S) ON THE USE OF LAND
- 8 AM709466 POSITIVE COVENANT
- 9 AM709467 POSITIVE COVENANT
- 10 AM709468 POSITIVE COVENANT
- 11 AP71853 CONSOLIDATION OF REGISTERED BY-LAWS
- 12 AP71853 INITIAL PERIOD EXPIRED

SCHEDULE OF UNIT ENTITLEMENT (AGGREGATE: 10000)

SCHEDULE OF UNIT ENTITLEMENT (AGGREGATE: 10000) (CONTINUED)

STRATA PLAN 95882

LOT	ENT	LOT	ENT	LOT	ENT	LOT	ENT
1	- 112	2	- 90	3	- 93	4	- 93
5	- 93	6	- 93	7	- 93	8	- 104
9	- 82	10	- 103	11	- 103	12	- 103
13	- 103	14	- 103	15	- 88	16	- 101
17	- 77	18	- 77	19	- 77	20	- 77
21	- 77	22	- 98	23	- 98	24	- 78
25	- 120	26	- 102	27	- 82	28	- 82
29	- 82	30	- 84	31	- 82	32	- 105
33	- 79	34	- 79	35	- 101	36	- 77
37	- 77	38	- 77	39	- 77	40	- 77
41	- 99	42	- 99	43	- 79	44	- 121
45	- 103	46	- 82	47	- 82	48	- 82
49	- 85	50	- 82	51	- 107	52	- 80
53	- 80	54	- 102	55	- 77	56	- 77
57	- 77	58	- 77	59	- 77	60	- 100
61	- 100	62	- 79	63	- 122	64	- 103
65	- 83	66	- 83	67	- 83	68	- 85
69	- 83	70	- 89	71	- 80	72	- 80
73	- 120	74	- 94	75	- 108	76	- 108
77	- 82	78	- 94	79	- 82	80	- 117
81	- 84	82	- 117	83	- 123	84	- 101
85	- 122	86	- 78	87	- 78	88	- 174
89	- 126	90	- 118	91	- 81	92	- 112
93	- 118	94	- 118	95	- 112	96	- 162
97	- 177	98	- 127	99	- 87	100	- 124
101	- 125	102	- 125	103	- 169		

NOTATIONS

UNREGISTERED DEALINGS: NIL

*** END OF SEARCH ***

PACIFIC

LOCATION PLAN

PARADE

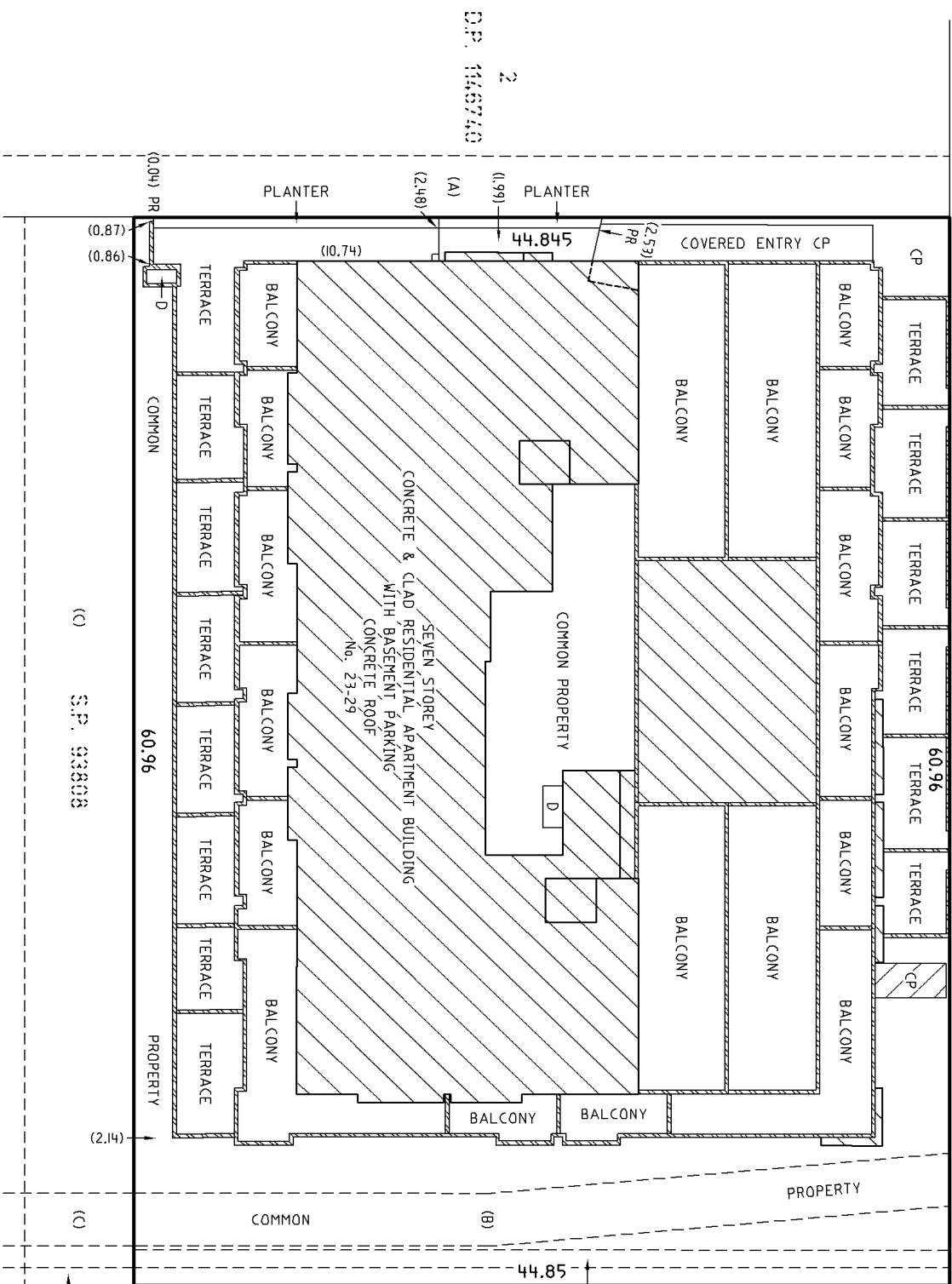

SURVEYOR
 Name: WARREN L. BEE
 Date: 01-09-2017
 Reference: 19786

PLAN OF SUBDIVISION OF LOT 1 IN
 D.P. 1231319

L.G.A. NORTHERN BEACHES
 Locality: DEE WHY
 Reduction Ratio: 1:250
 Lengths are in metres

REGISTERED
 20.09.2017

SP95882

- NOTES:
- D - DENOTES DUCT - COMMON PROPERTY
 - CP - DENOTES COMMON PROPERTY
 - PR - DENOTES PROLONGATION OF FACE OF WALL
 - (A) EASEMENT TO DRAIN WATER 2.4 & 3.5 WIDE (D.P. 1146740)
 - (B) RIGHT OF CARRIAGEWAY 3 WIDE & VARIABLE WIDTH (D.P. 120083)
 - (C) RIGHT OF ACCESS 6 WIDE (D.P. 120083)
 - (D) EASEMENT TO DRAIN WATER 1 WIDE (D.P. 120700)
 - (E) EASEMENT FOR SERVICES 1 & 3.7 WIDE (AK630238)

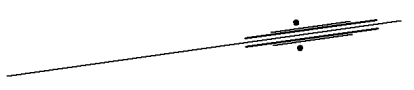

BASEMENT 2

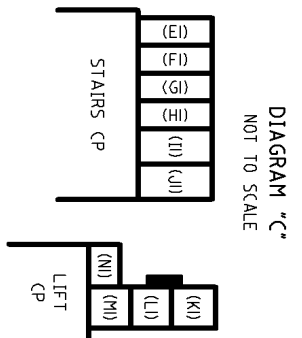
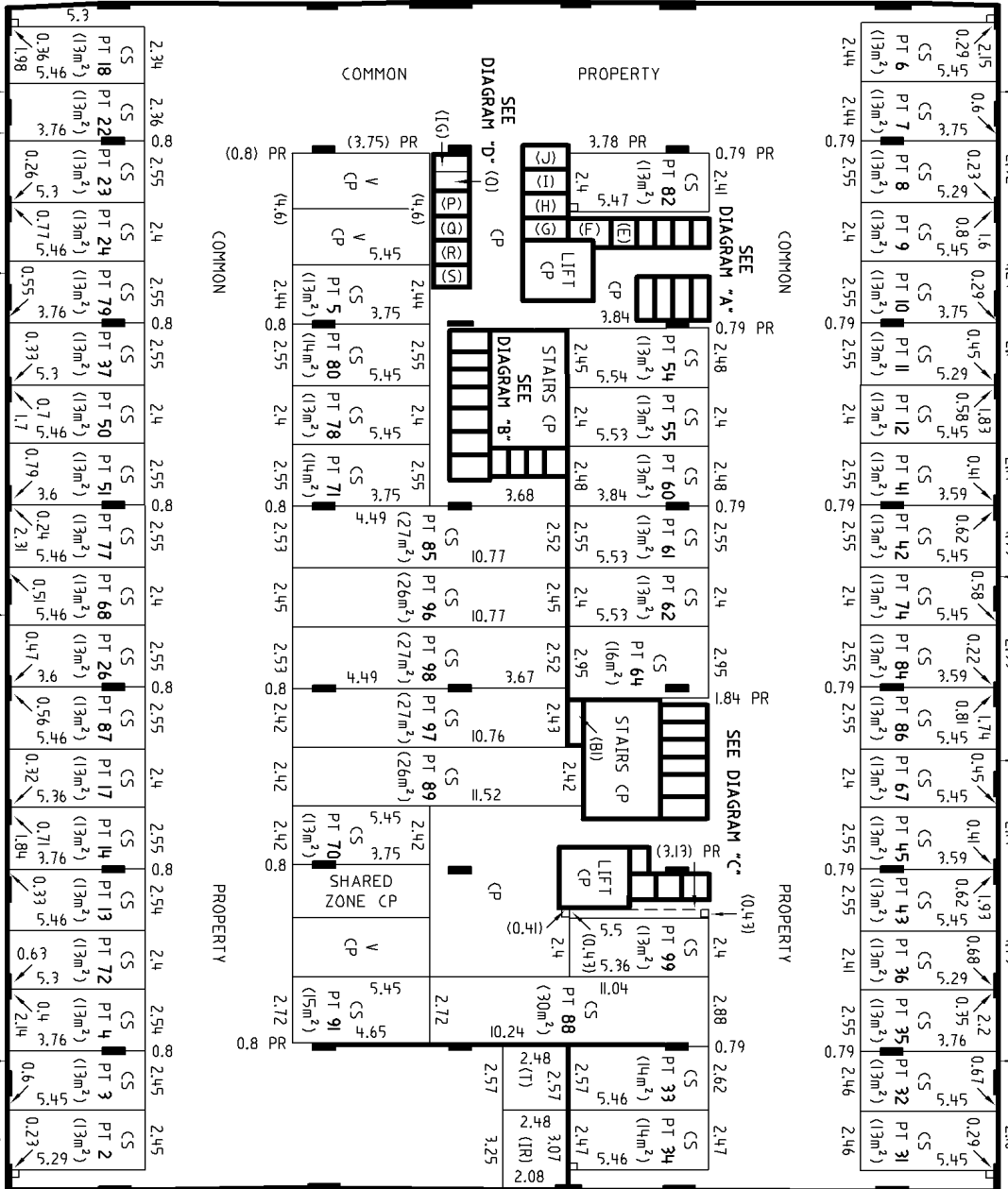

- STORAGE AREAS**
- (A) PT 55 (1m²)
 - (B) PT 41 (1m²)
 - (C) PT 9 (1m²)
 - (D) PT 66 (1m²)
 - (E) PT 82 (2m²)
 - (F) PT 82 (2m²)
 - (G) PT 98 (2m²)
 - (H) PT 102 (2m²)
 - (I) PT 101 (2m²)
 - (J) PT 35 (1m²)
 - (K) PT 35 (1m²)
 - (L) PT 36 (1m²)
 - (M) PT 43 (1m²)
 - (N) PT 60 (1m²)
 - (O) PT 22 (1m²)
 - (P) PT 24 (2m²)
 - (Q) PT 37 (2m²)
 - (R) PT 51 (2m²)
 - (S) PT 77 (2m²)
 - (T) PT 33 (6m²)
 - (U) PT 93 (1m²)
 - (V) PT 26 (1m²)
 - (W) PT 68 (1m²)
 - (X) PT 72 (1m²)
 - (Y) PT 95 (1m²)
 - (Z) PT 85 (2m²)
 - (AA) PT 17 (1m²)
 - (AB) PT 97 (2m²)
 - (AC) PT 64 (1m²)
 - (AD) PT 32 (1m²)
 - (AE) PT 31 (1m²)
 - (AF) PT 70 (1m²)
 - (AG) PT 71 (1m²)
 - (AH) PT 45 (1m²)
 - (AI) PT 67 (2m²)
 - (AJ) PT 90 (2m²)
 - (AK) PT 100 (1m²)
 - (AL) PT 69 (1m²)
 - (AM) PT 2 (1m²)
 - (AN) PT 54 (1m²)
 - (AO) PT 18 (1m²)
 - (AP) PT 34 (8m²)

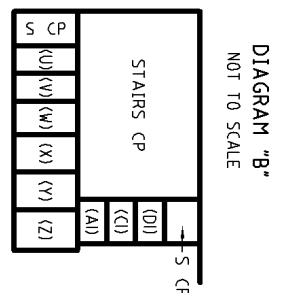
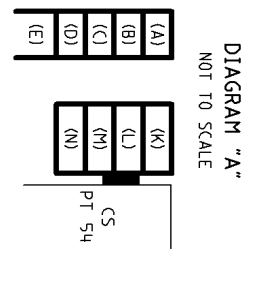
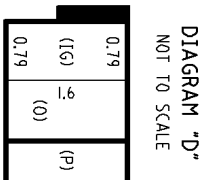

NOTES:

- S - DENOTES STORAGE
- V - DENOTES VISITOR PARKING
- CS - DENOTES CAR SPACE
- CP - DENOTES COMMON PROPERTY
- PR - DENOTES PROLONGATION OF FACE OF WALL OR COLUMN

SURVEYOR
Name: WARREN L. BEE
Date: 01-09-2017
Reference: 19786

PLAN OF SUBDIVISION OF LOT 1 IN D.P. 1231319

L.G.A. NORTHERN BEACHES
Locality: DEE WHY
Reduction Ratio: 1:200
Lengths are in metres

REGISTERED
20.09.2017

THE AREAS SHOWN ARE FOR THE PURPOSE OF THE STRATA SCHEMES DEVELOPMENT ACT 2015 ONLY AND ARE APPROXIMATE

SP95882

GROUND FLOOR

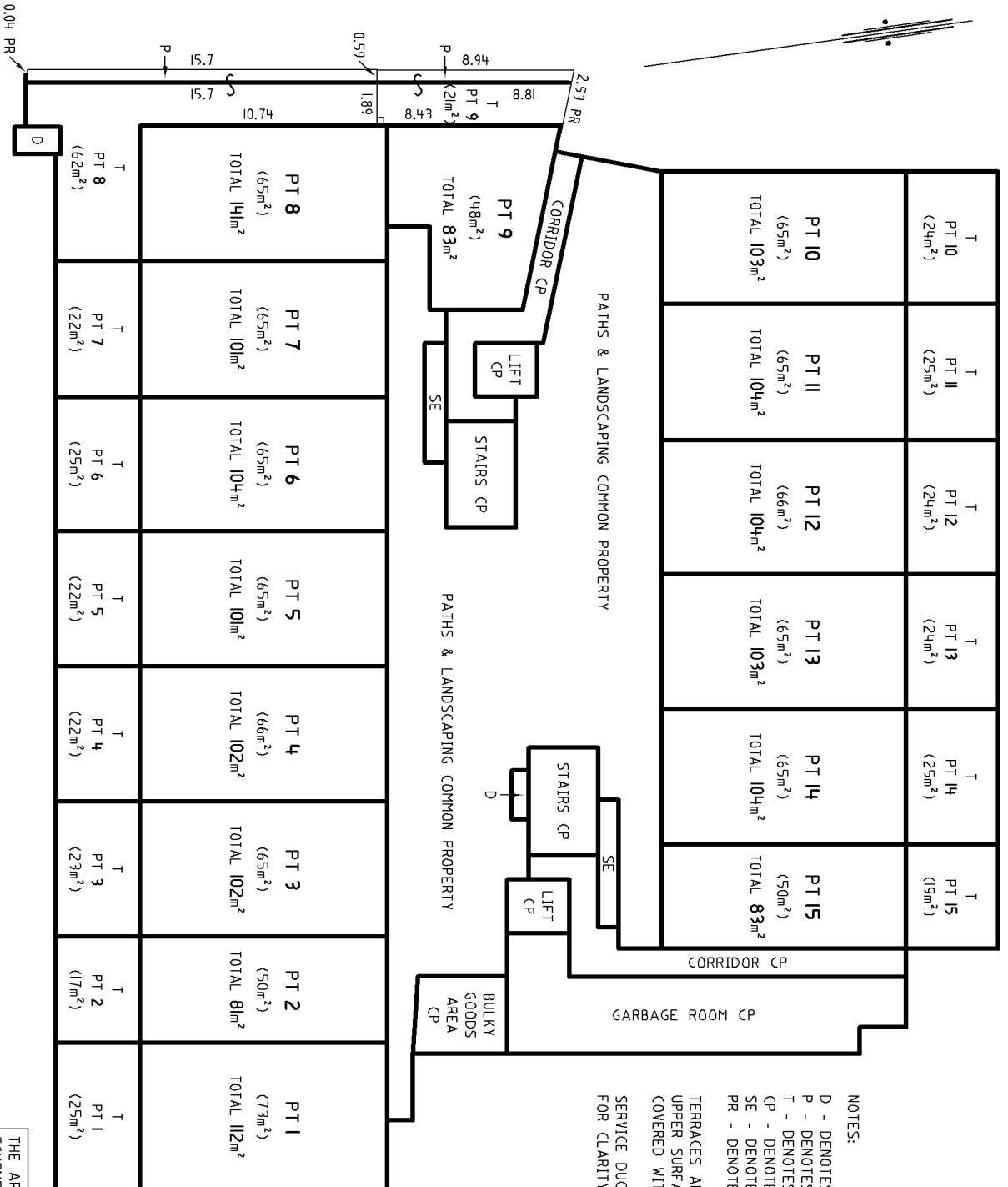

NOTES:

- D - DENOTES DUCT - COMMON PROPERTY
- P - DENOTES PLANTER
- T - DENOTES TERRACE
- CP - DENOTES COMMON PROPERTY
- SE - DENOTES SERVICES - COMMON PROPERTY
- PR - DENOTES PROLONGATION OF FACE OF WALL

TERRACES ARE LIMITED IN HEIGHT TO 3 METRES ABOVE THE UPPER SURFACE OF THEIR RESPECTIVE FLOORS EXCEPT WHERE COVERED WITHIN THIS LIMIT.

SERVICE DUCTS ARE COMMON PROPERTY & MAY NOT BE SHOWN FOR CLARITY OF DRAWING.

THE AREAS SHOWN ARE FOR THE PURPOSE OF THE STRATA SCHEMES DEVELOPMENT ACT 2015 ONLY AND ARE APPROXIMATE

SURVEYOR
Name: WARREN L. BEE
Date: 01-09-2017
Reference: 19786

PLAN OF SUBDIVISION OF LOT 1 IN
D.P. 1231319

L.G.A. NORTHERN BEACHES
Locality: DEE WHY
Reduction Ratio: 1:200
Lengths are in metres

REGISTERED
20.09.2017

SP95882

LEVEL 1

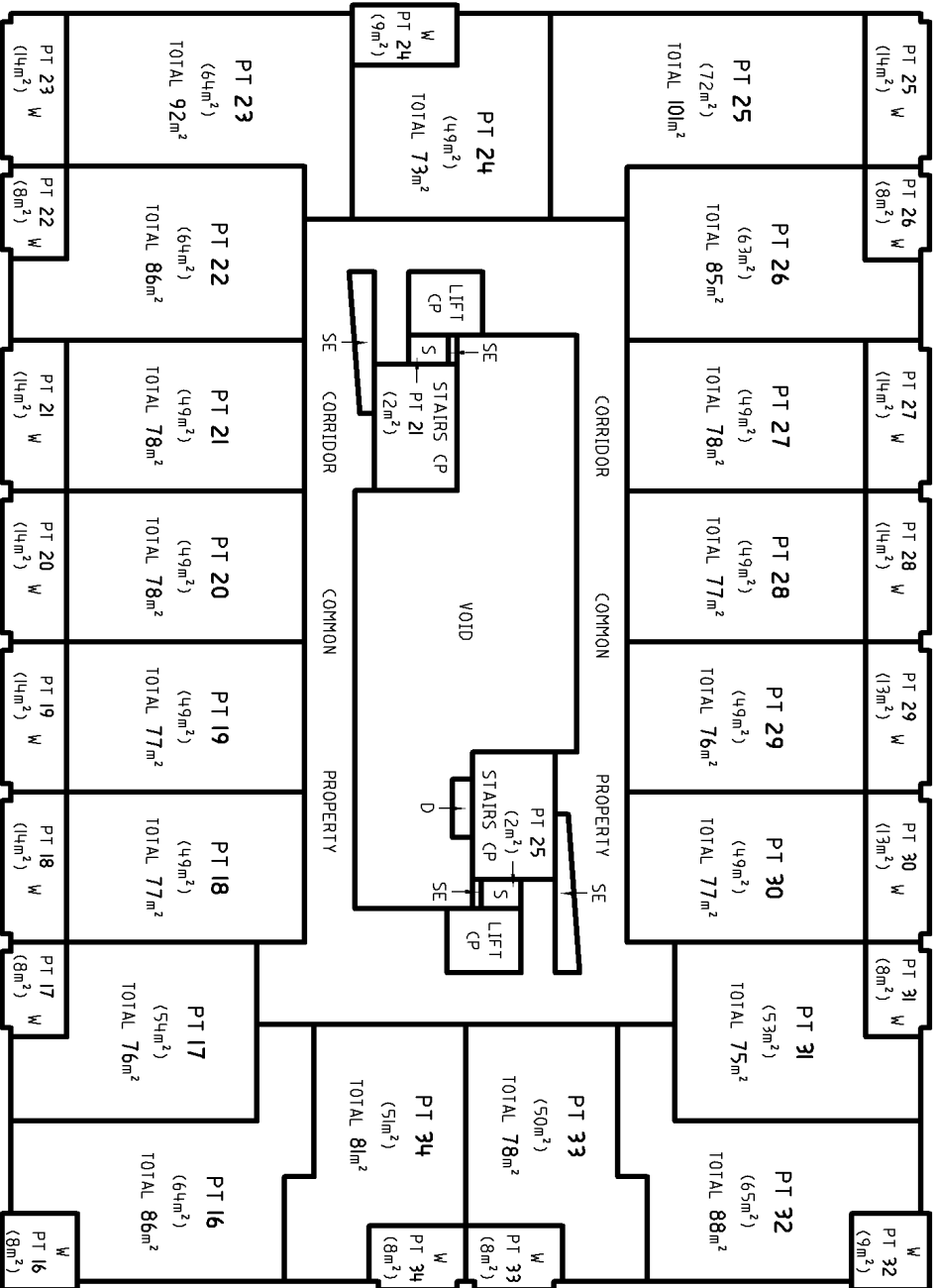

NOTES:

- D - DENOTES DUCT - COMMON PROPERTY
 - S - DENOTES STORAGE
 - W - DENOTES WINTER GARDEN - WHOLLY COVERED
 - CP - DENOTES COMMON PROPERTY
 - SE - DENOTES SERVICES - COMMON PROPERTY
- ALL METAL PERGOLAS, METAL & GLASS BALUSTRADES, METAL AWNINGS & METAL SCREENS ON WINTER GARDENS ARE COMMON PROPERTY.
- SERVICE DUCTS ARE COMMON PROPERTY & MAY NOT BE SHOWN FOR CLARITY OF DRAWING.

SURVEYOR
Name: WARREN L. BEE
Date: 01-09-2017
Reference: 19786

PLAN OF SUBDIVISION OF LOT 1 IN
D.P. 1231319

L.G.A. NORTHERN BEACHES
Locality: DEE WHY
Reduction Ratio: 1:200
Lengths are in metres

REGISTERED
20.09.2017

SP95882

THE AREAS SHOWN ARE FOR THE PURPOSE OF THE STRATA SCHEMES DEVELOPMENT ACT 2015 ONLY AND ARE APPROXIMATE

LEVEL 2

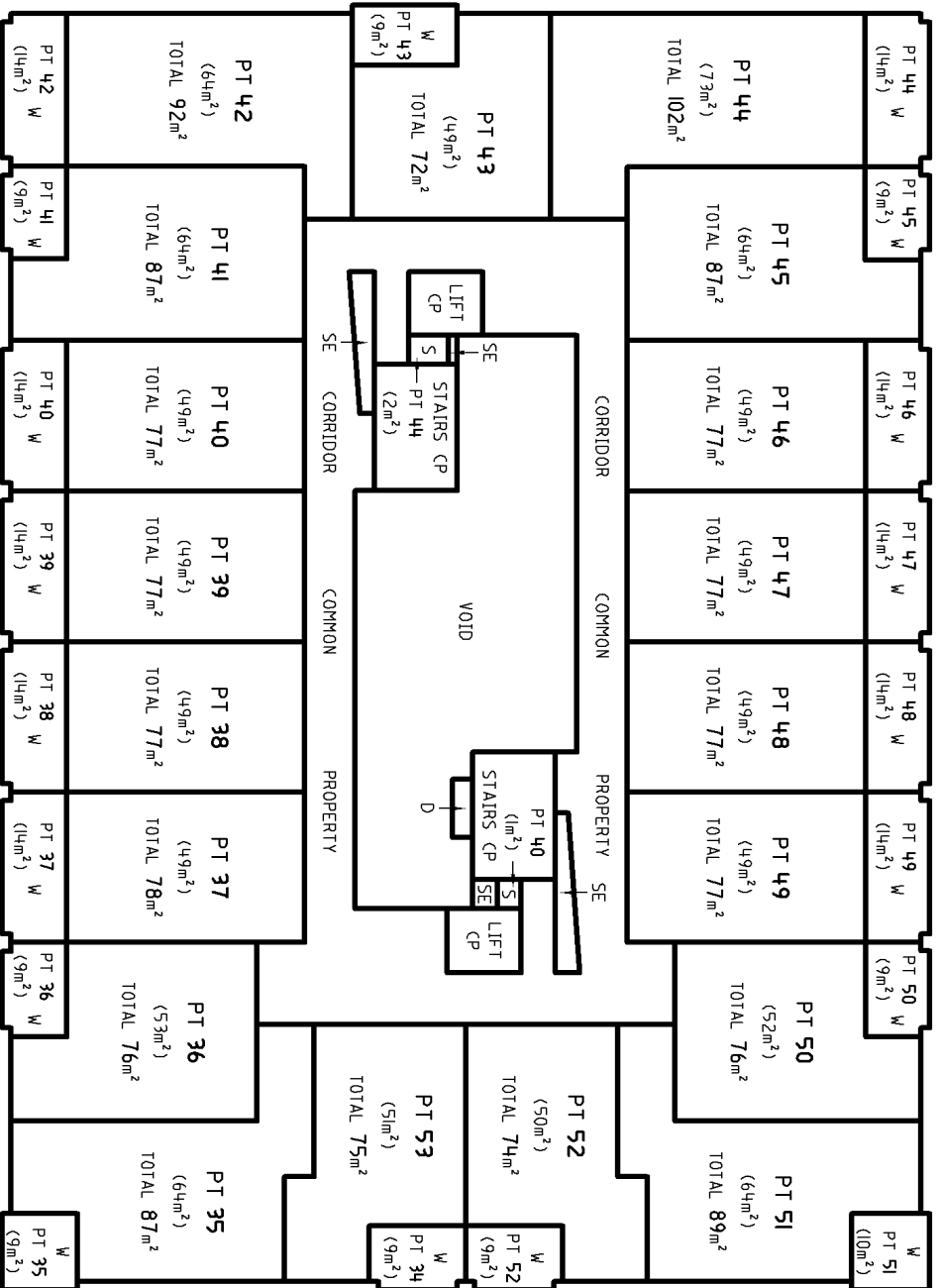

NOTES:

- D - DENOTES DUCT - COMMON PROPERTY
- S - DENOTES STORAGE
- W - DENOTES WINTER GARDEN - WHOLLY COVERED
- CP - DENOTES COMMON PROPERTY
- SE - DENOTES SERVICES - COMMON PROPERTY

ALL METAL PERGOLAS, METAL & GLASS BALUSTRADES, METAL AWNINGS & METAL SCREENS ON WINTER GARDENS ARE COMMON PROPERTY.

SERVICE DUCTS ARE COMMON PROPERTY & MAY NOT BE SHOWN FOR CLARITY OF DRAWING.

SURVEYOR
Name: WARREN L. BEE
Date: 01-09-2017
Reference: 19786

PLAN OF SUBDIVISION OF LOT 1 IN
D.P. 1231319

L.G.A. NORTHERN BEACHES
Locality: DEE WHY
Reduction Ratio: 1:200
Lengths are in metres



REGISTERED
20.09.2017

SP95882

THE AREAS SHOWN ARE FOR THE PURPOSE OF THE STRATA SCHEMES DEVELOPMENT ACT 2015 ONLY AND ARE APPROXIMATE

LEVEL 3

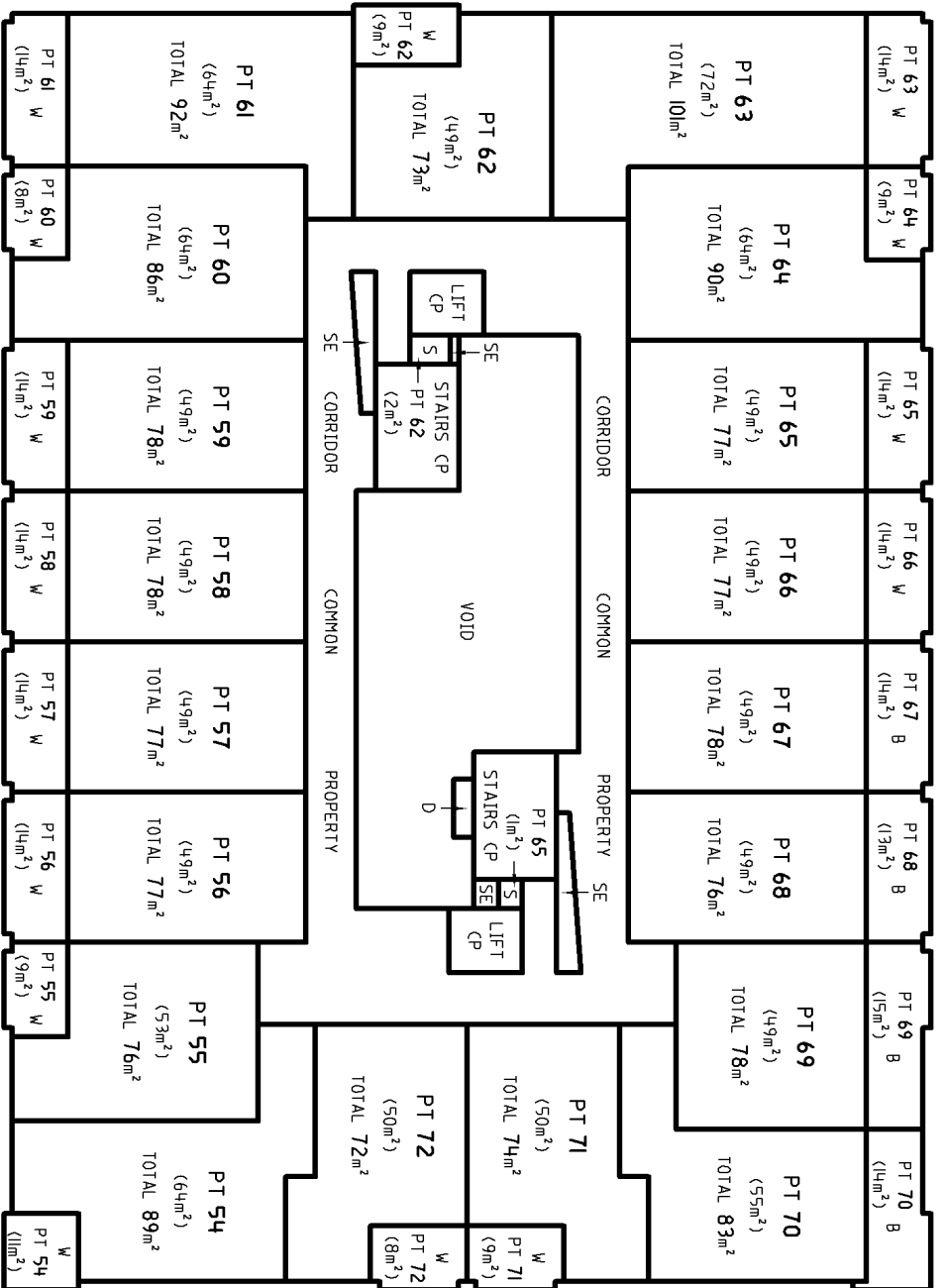

NOTES:

- B - DENOTES BALCONY
- D - DENOTES DUCT - COMMON PROPERTY
- S - DENOTES STORAGE
- W - DENOTES WINTER GARDEN - WHOLLY COVERED
- CP - DENOTES COMMON PROPERTY
- SE - DENOTES SERVICES - COMMON PROPERTY

BALCONIES & ARE LIMITED IN HEIGHT TO 3 METRES ABOVE THE UPPER SURFACE OF THEIR RESPECTIVE FLOORS EXCEPT WHERE COVERED WITHIN THIS LIMIT.

ALL METAL PERGOLAS, METAL & GLASS BALUSTRADES, METAL AWNINGS & METAL SCREENS ON BALCONIES & WINTER GARDENS ARE COMMON PROPERTY.

SERVICE DUCTS ARE COMMON PROPERTY & MAY NOT BE SHOWN FOR CLARITY OF DRAWING.

SURVEYOR
Name: WARREN L. BEE
Date: 01-09-2017
Reference: 19786

PLAN OF SUBDIVISION OF LOT 1 IN
D.P. 1231319

L.G.A. NORTHERN BEACHES
Locality: DEE WHY
Reduction Ratio: 1:200
Lengths are in metres

REGISTERED
20.09.2017

SP95882

THE AREAS SHOWN ARE FOR THE PURPOSE OF THE STRATA SCHEMES DEVELOPMENT ACT 2015 ONLY AND ARE APPROXIMATE

LEVEL 4

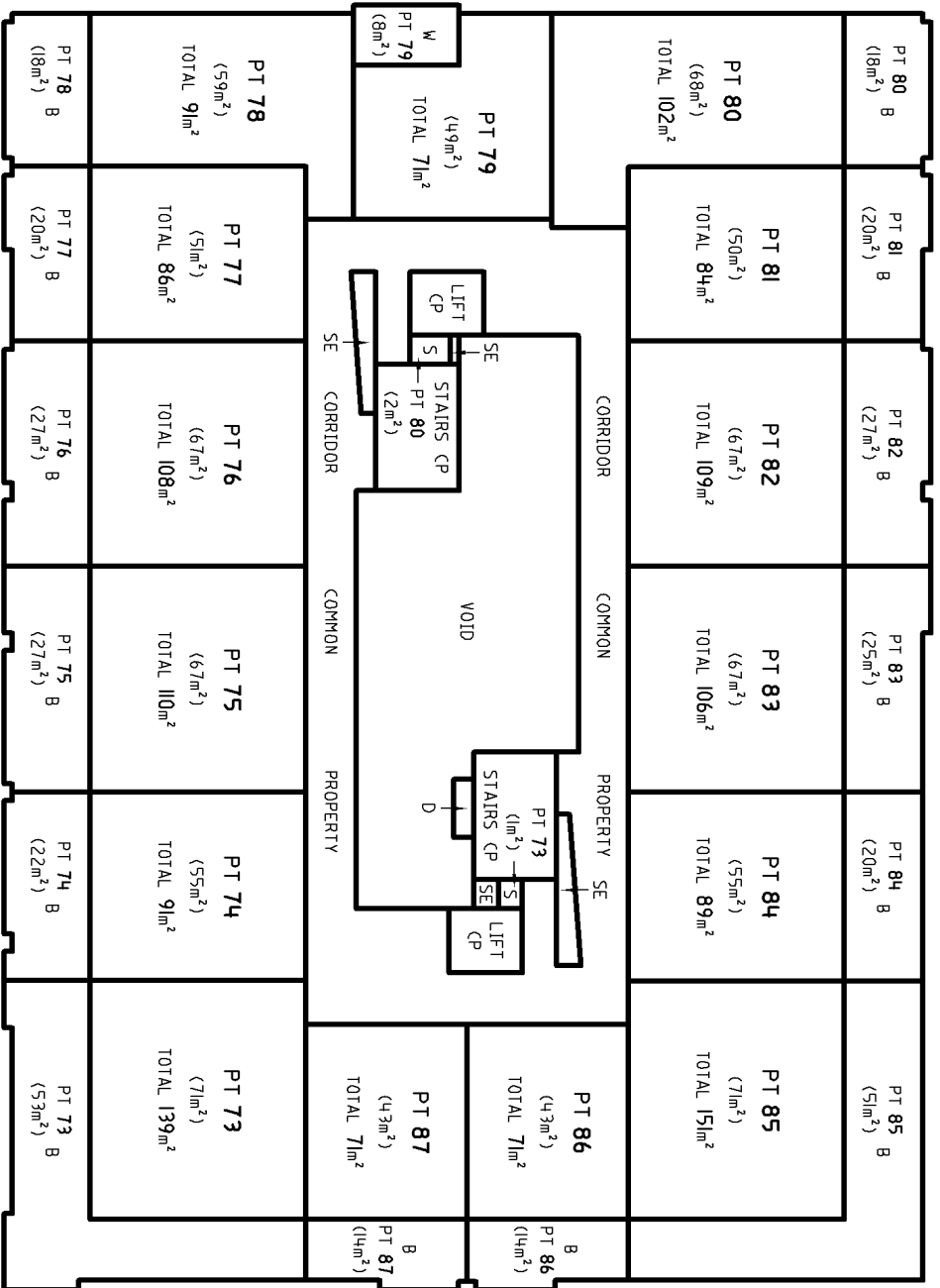

NOTES:

- B - DENOTES BALCONY
- D - DENOTES DUCT - COMMON PROPERTY
- S - DENOTES STORAGE
- W - DENOTES WINTER GARDEN - WHOLLY COVERED
- CP - DENOTES COMMON PROPERTY
- SE - DENOTES SERVICES - COMMON PROPERTY

BALCONIES ARE LIMITED IN HEIGHT TO 3 METRES ABOVE THE UPPER SURFACE OF THEIR RESPECTIVE FLOORS EXCEPT WHERE COVERED WITHIN THIS LIMIT.
 ALL METAL PERGOLAS, METAL & GLASS BALUSTRADES, METAL AWNINGS & METAL SCREENS ON BALCONIES & WINTER GARDENS ARE COMMON PROPERTY.
 SERVICE DUCTS ARE COMMON PROPERTY & MAY NOT BE SHOWN FOR CLARITY OF DRAWING.

THE AREAS SHOWN ARE FOR THE PURPOSE OF THE STRATA SCHEMES DEVELOPMENT ACT 2015 ONLY AND ARE APPROXIMATE

SURVEYOR
 Name: WARREN L. BEE
 Date: 01-09-2017
 Reference: 19786

PLAN OF SUBDIVISION OF LOT 1 IN
 D.P. 1231319

L.G.A. NORTHERN BEACHES
 Locality: DEE WHY
 Reduction Ratio: 1:200
 Lengths are in metres

REGISTERED
 20.09.2017

SP95882

LEVEL 5

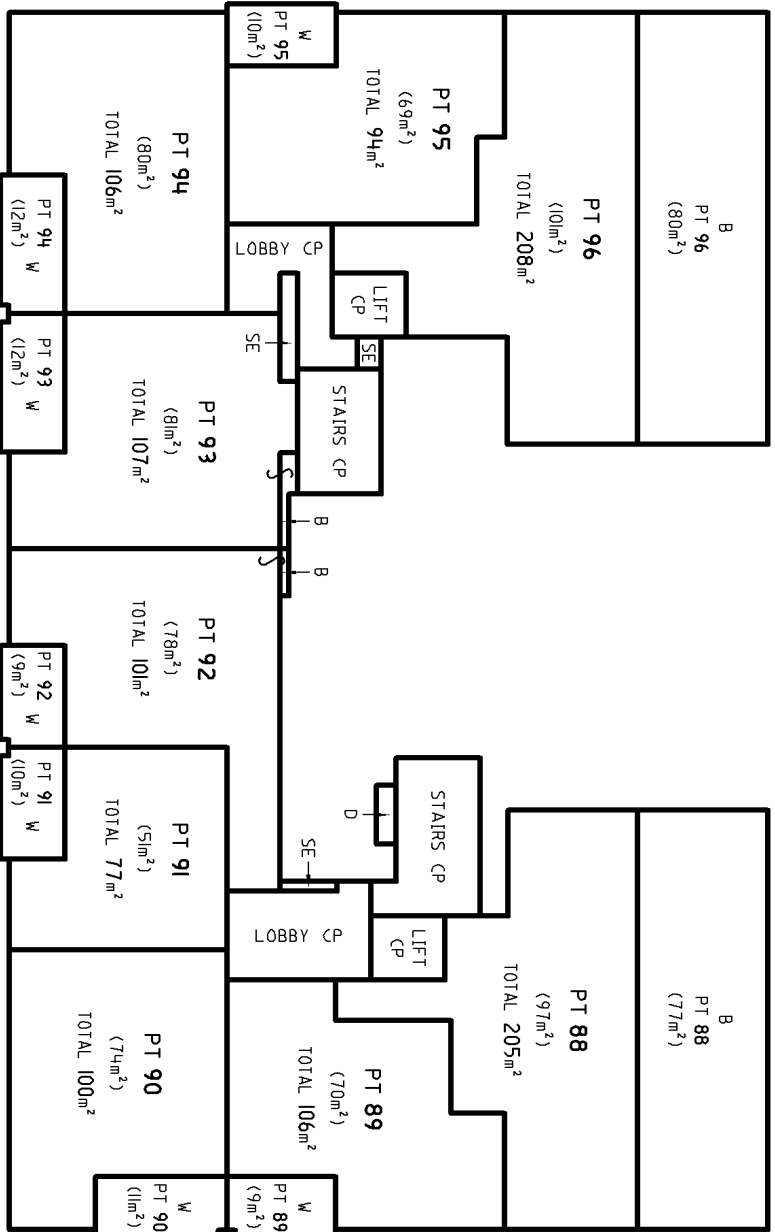

NOTES:
 B - DENOTES BALCONY
 D - DENOTES DUCT - COMMON PROPERTY
 W - DENOTES WINTER GARDEN - WHOLLY COVERED
 CP - DENOTES COMMON PROPERTY
 SE - DENOTES SERVICES - COMMON PROPERTY
 BALCONIES ARE LIMITED IN HEIGHT TO 3 METRES ABOVE THE UPPER SURFACE OF THEIR RESPECTIVE FLOORS EXCEPT WHERE COVERED WITHIN THIS LIMIT.
 ALL METAL PERGOLAS, METAL & GLASS BALUSTRADES, METAL AWNINGS & METAL SCREENS ON BALCONIES & WINTER GARDENS ARE COMMON PROPERTY.
 SERVICE DUCTS ARE COMMON PROPERTY & MAY NOT BE SHOWN FOR CLARITY OF DRAWING.

THE AREAS SHOWN ARE FOR THE PURPOSE OF THE STRATA SCHEMES DEVELOPMENT ACT 2015 ONLY AND ARE APPROXIMATE

SURVEYOR Name: WARREN L. BEE Date: 01-09-2017 Reference: 19786	PLAN OF SUBDIVISION OF LOT 1 IN D.P. 1231319	L.G.A: NORTHERN BEACHES Locality: DEE WHY Reduction Ratio: 1:200 Lengths are in metres	REGISTERED  20.09.2017	SP95882
---	---	---	--	---------

LEVEL 6

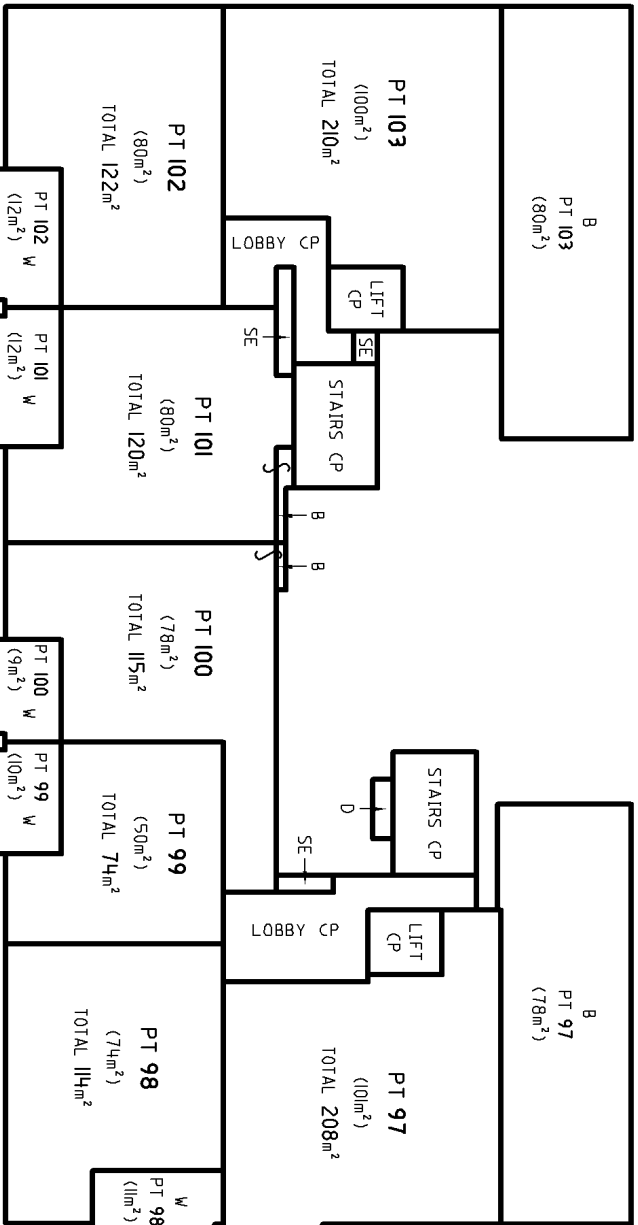

NOTES:

- B - DENOTES BALCONY
- D - DENOTES DUCT - COMMON PROPERTY
- W - DENOTES WINTER GARDEN - WHOLLY COVERED
- CP - DENOTES COMMON PROPERTY
- SE - DENOTES SERVICES - COMMON PROPERTY

BALCONIES ARE LIMITED IN HEIGHT TO 3 METRES ABOVE THE UPPER SURFACE OF THEIR RESPECTIVE FLOORS EXCEPT WHERE COVERED WITHIN THIS LIMIT.

ALL METAL PERGOLAS, METAL & GLASS BALUSTRADES, METAL AWNINGS & METAL SCREENS ON BALCONIES & WINTER GARDENS ARE COMMON PROPERTY.

SERVICE DUCTS ARE COMMON PROPERTY & MAY NOT BE SHOWN FOR CLARITY OF DRAWING.

THE AREAS SHOWN ARE FOR THE PURPOSE OF THE STRATA SCHEMES DEVELOPMENT ACT 2015 ONLY AND ARE APPROXIMATE

SURVEYOR
Name: WARREN L. BEE
Date: 01-09-2017
Reference: 19786

PLAN OF SUBDIVISION OF LOT 1 IN
D.P. 1231319

L.G.A. NORTHERN BEACHES
Locality: DEE WHY
Reduction Ratio: 1:200
Lengths are in metres

REGISTERED
20.09.2017

SP95882

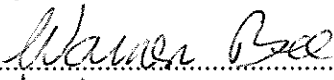
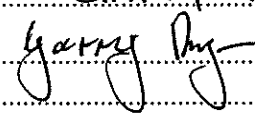
SP FORM 3.01	STRATA PLAN ADMINISTRATION SHEET	Sheet 1 of 3 sheet(s)
Office Use Only Registered:  20.09.2017	<h1 style="margin: 0;">SP95882</h1>	
PLAN OF SUBDIVISION OF: LOT 1 IN DP 1231319	LGA: Northern Beaches Locality: Dee Why Parish: Manly Cove County: Cumberland	
This is a *FREEHOLD/*LEASEHOLD Strata Scheme		
Address for Service of Documents 23 Pacific Parade DEE WHY NSW 2099 <small>Provide an Australian postal address including a postcode</small>	The by-laws adopted for the scheme are: * Model by-laws for residential strata schemes together with: Keeping of animals: Option *A/*B Smoke penetration: Option *A/*B (see Schedule 3 Strata Schemes Management Regulation 2016) * The strata by-laws lodged with the plan.	
<p style="text-align: center;">Surveyor's Certificate</p> I Warren L Bee of OP Box 330 Forestville NSW 2087..... being a land surveyor registered under the <i>Surveying and Spatial Information Act 2002</i> , certify that the information shown in the accompanying plan is accurate and each applicable requirement of Schedule 1 of the <i>Strata Schemes Development Act 2015</i> has been met. *The building encroaches on: *(a) a public place *(b) land other than a public place and an appropriate easement to permit the encroachment has been created by ^ Signature:  Date: 1/9/2017 Surveyor ID: 448..... Surveyor's Reference: 19786..... <small>^ Insert the deposited plan number or dealing number of the instrument that created the easement</small>	<p style="text-align: center;">Strata Certificate (Accredited Certifier)</p> I <u>GARRY RYAN</u> being an Accredited Certifier, accreditation number <u>BP00565</u> , certify that in regards to the strata plan with this certificate, I have made the required inspections and I am satisfied the plan complies with clause 17 <i>Strata Schemes Development Regulation 2016</i> and the relevant parts of Section 58 <i>Strata Schemes Development Act 2015</i> . *(a) This plan is part of a development scheme. *(b) The building encroaches on a public place and in accordance with section 62(3) <i>Strata Schemes Development Act 2015</i> the local council has granted a relevant planning approval that is in force for the building with the encroachment or for the subdivision specifying the existence of the encroachment. *(c) This certificate is given on the condition contained in the relevant planning approval that lot(s) ^..... will be created as utility lots and restricted in accordance with section 63 <i>Strata Schemes Development Act 2015</i>. Certificate Reference: <u>2A/2017</u> Relevant Planning Approval No.: <u>CDC8/2017</u> issued by: <u>GARRY RYAN</u> Signature:  Date: 7/9/2017 <small>^ Insert lot numbers of proposed utility lots.</small>	
<small>* Strike through if inapplicable</small>		

SP FORM 3.07

STRATA PLAN ADMINISTRATION SHEET

Sheet 2 of 3 sheet(s)

Office Use Only

Office Use Only

Registered:  20.09.2017

SP95882

VALUER'S CERTIFICATE

I, MICHAEL ROGERS being a qualified valuer, as defined in the *Strata Schemes Development Act 2015*, certify that the unit entitlements shown in the schedule herewith are apportioned in accordance with Schedule 2 *Strata Schemes Development Act 2015*

Signature:  Date 22/08/2017

SCHEDULE OF UNIT ENTITLEMENT

Lot No	Unit Entitlement	Lot No	Unit Entitlement	Lot No	Unit Entitlement
1	112	36	77	71	80
2	90	37	77	72	80
3	93	38	77	73	120
4	93	39	77	74	94
5	93	40	77	75	108
6	93	41	99	76	108
7	93	42	99	77	82
8	104	43	79	78	94
9	82	44	121	79	82
10	103	45	103	80	117
11	103	46	82	81	84
12	103	47	82	82	117
13	103	48	82	83	123
14	103	49	85	84	101
15	88	50	82	85	122
16	101	51	107	86	78
17	77	52	80	87	78
18	77	53	80	88	174
19	77	54	102	89	126
20	77	55	77	90	118
21	77	56	77	91	81
22	98	57	77	92	112
23	98	58	77	93	118
24	78	59	77	94	118
25	120	60	100	95	112
26	102	61	100	96	162
27	82	62	79	97	177
28	82	63	122	98	127
29	82	64	103	99	87
30	84	65	83	100	124
31	82	66	83	101	125
32	105	67	83	102	125
33	79	68	85	103	169
34	79	69	83	Aggregate	10,000
35	101	70	89		

SP FORM 3.08 (Annexure)	STRATA PLAN ADMINISTRATION SHEET	Sheet 3 of 3 sheet(s)
-------------------------	---	-----------------------

Office Use Only	Office Use Only
Registered:  20.09.2017	SP95882

This sheet is for the provision of the following information as required:

- Any information which cannot fit in the appropriate panel of any previous administration sheets
- Statements of intention to create and or release affecting interests in accordance with section 88B *Conveyancing Act 1919*
- Signatures and seals- see section 22 *Strata Schemes Development Act 2015*

EXECUTED by DEE WHY PROPERTIES NO 2 PTY LTD ACN 166 135 422 in accordance with section 127(1) of the Corporations Act 2001 (Cth) by authority of its directors:

Secretary (Signature)

Justin John Kucic
JUSTIN JOHN KUCIC

Name of Secretary (Print Name)

Bruce Warren Baudinet

Director (Signature)

BRUCE WARREN BAUDINET

Name of Director (Print Name)

SIGNED SEALED AND DELIVERED for and on behalf of NATIONAL AUSTRALIA BANK LIMITED ABN 12 004 044 937 by its Attorney who holds the position of Level 2 Attorney under Power of Attorney Registered No 39 Book 4512 in the presence of:

Brocke Williams

Witness

Brocke Williams

255 George St, Sydney 2000

Rachel Tweedy

RACHEL TWEEDY
Associate Director
NAB Corporate Property NSW

0 10 20 30 40 50 60 70 80 90 100 110 120 130 140 150

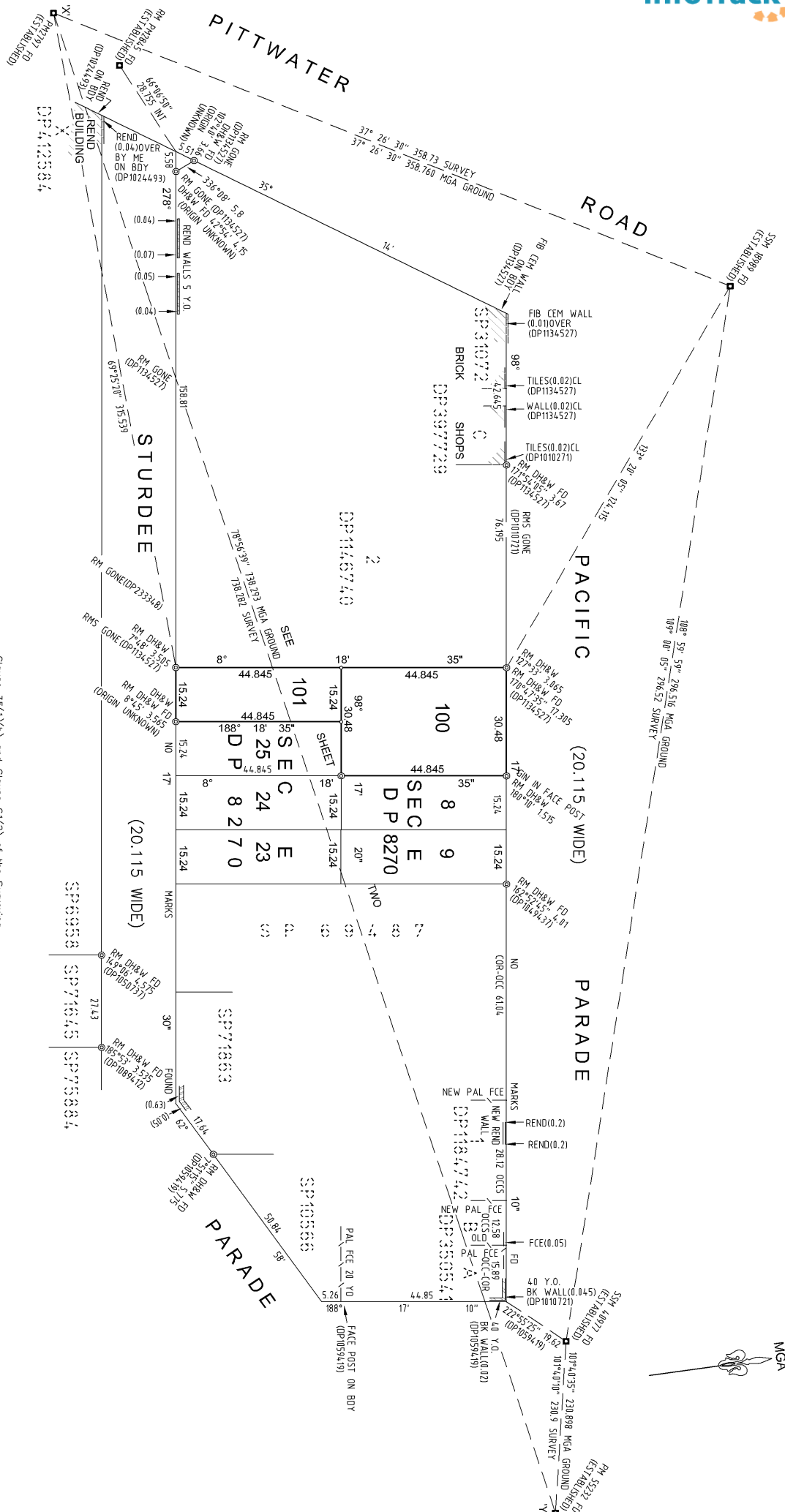

PM 2797 TO PM 2845 40°53'06" 162.631 MGA GROUND
 PM 2845 TO SSM 18989 40°52'40" 162.63 BY SURVEY
 PM 2845 TO SSM 18989 34°35'40" 196.666 MGA GROUND
 34°36'00" 196.63 BY SURVEY

Clause 35(1)(b) and Clause 61(2) of the Surveying and Spatial Information Regulation 2006

Mark	MGA Easting	MGA Northing	Class	Order	Method	Origin
PM 2797	340 911.922	6 263 524.661	B	2	SCIMS	
PM 55252	341 636.443	6 263 666.228	B	2	SCIMS	
SSM18989	341 130.01	6 263 809.48	D	4	SCIMS	
SSM40977	341 410.345	6 263 712.954	B	2	SCIMS	
PM 2845	341 018.361	6 263 647.602	B	2	SCIMS	

MGA Co-ordinates adopted from SCIMS as at 5 September 2014
 Combined Scale Factor = 0.9999904 Zone 56

Surveyor: CHRISTOPHER PATRICK HILL
 Surveyors Ref: D1737-D2170-PP
 Date of Survey: 9th September 2014

PLAN OF SUBDIVISION OF LOT 1 IN DP776401
 AND EASEMENTS OVER LOTS 9, 23, 24 AND 25
 SECTION E IN DP8270

LGA: WARRINGAH
 Locality: DEE WHY
 Subdivision No. SC 2015/0004
 Lengths are in metres. Reduction Ratio 1:750

Registered
 9.4.2015

DP1201083



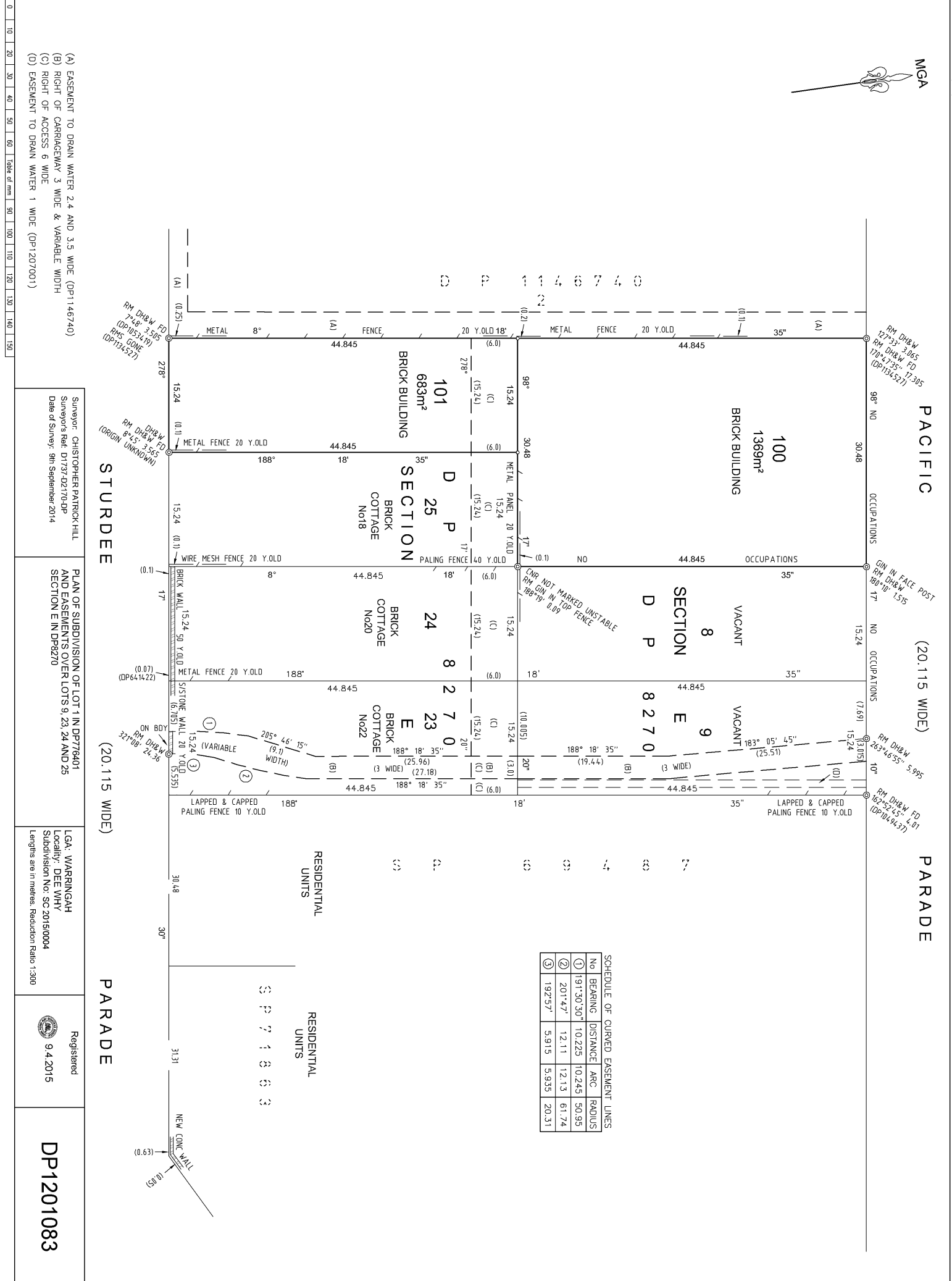

SCHEDULE OF CURVED EASEMENT LINES

No	BEARING	DISTANCE	ARC	RADIUS
①	191°30'30"	10.225	10.245	50.95
②	201°47'	12.11	12.13	61.74
③	192°57'	5.915	5.935	20.31

- (A) EASEMENT TO DRAIN WATER 2.4 AND 3.5 WIDE (DP1146740)
- (B) RIGHT OF CARRIAGEWAY 3 WIDE & VARIABLE WIDTH
- (C) RIGHT OF ACCESS 6 WIDE
- (D) EASEMENT TO DRAIN WATER 1 WIDE (DP1207001)

Surveyor: CHRISTOPHER PATRICK HILL
 Surveyors Ref: D1737-D2170-0P
 Date of Survey: 9th September 2014

PLAN OF SUBDIVISION OF LOT 1 IN DP776401
 AND EASEMENTS OVER LOTS 9, 23, 24 AND 25
 SECTION E IN DP8270

LGA: WARRINGAH
 Locality: DEE WHY
 Subdivision No. SC 2015/0004
 Lengths are in metres. Reduction Ratio 1:300

Registered
 9.4.2015

DP1201083



PLAN FORM 6 (2012)

WARNING: Creasing or folding will lead to rejection

ePlan

DEPOSITED PLAN ADMINISTRATION SHEET

Sheet 1 of 2 sheet(s)

Office Use Only

Office Use Only

Registered:  9.4.2015

Title System: TORRENS

Purpose: SUBDIVISION

DP1201083

PLAN OF SUBDIVISION OF LOT 1 IN DP 776401 AND EASEMENTS OVER LOTS 9,23,24 AND 25 SECTION E IN DP 8270

LGA: WARRINGAH

Locality: DEE WHY

Parish: MANLY COVE

County: CUMBERLAND

Crown Lands NSW/Western Lands Office Approval

I, (Authorised Officer) in approving this plan certify that all necessary approvals in regard to the allocation of the land shown herein have been given.

Signature:

Date:

File Number:

Office:

Survey Certificate

I, CHRISTOPHER PATRICK HILL of PROJECT SURVEYORS PO BOX 4004 MACQUARIE CENTRE NSW 2113 a surveyor registered under the *Surveying and Spatial Information Act 2002*, certify that:

*(a) The land shown in the plan was surveyed in accordance with the *Surveying and Spatial Information Regulation 2012*, is accurate and the survey was completed on 9 September 2014

~~*(b) The part of the land shown in the plan (*being/*excluding A.....) was surveyed in accordance with the *Surveying and Spatial Information Regulation 2012*, is accurate and the survey was completed on..... the part not surveyed was compiled in accordance with that Regulation.~~

*(c) The land shown in this plan was compiled in accordance with the *Surveying and Spatial Information Regulation 2012*.

Signature:  Dated: 2.2.2015

Surveyor ID: 95

Datum Line: 'X' - 'Y'

Type: *Urban/*Rural

The terrain is *Level-Undulating / *Steep-Mountainous.

*Strike through if inapplicable.

*Specify the land actually surveyed or specify any land shown in the plan that is not the subject of the survey.

Subdivision Certificate

I, Robert Barbuto *Authorised Person/*General Manager/*Accredited Certifier, certify that the provisions of s.109J of the *Environmental Planning and Assessment Act 1979* have been satisfied in relation to the proposed subdivision, new road or reserve set out herein.

Signature: 

Accreditation number:

Consent Authority: WARRINGAH COUNCIL

Date of endorsement: 02/03/2015

Subdivision Certificate number: SC 2015/0004

File number: DA 2013/1519

*Strike through if inapplicable.

Statements of intention to dedicate public roads, public reserves and drainage reserves.

Plans used in the preparation of survey/compilation.

DP 8270	DP 233348	DP 641422	DP 776401
DP 1010721	DP 1024493	DP 1049437	DP 1050737
DP 1059419	DP 1089212	DP 1134527	DP 1146740
DP 1184742			

If space is insufficient continue on PLAN FORM 6A

Signatures, Seals and Section 88B Statements should appear on PLAN FORM 6A

Surveyor's Reference: D1737-D2170-DP

PLAN FORM 6A (2012)

WARNING: Creasing or folding will lead to rejection

ePlan

DEPOSITED PLAN ADMINISTRATION SHEET

Sheet 2 of 2 sheet(s)

Office Use Only	Office Use Only
Registered:  9.4.2015	DP1201083
PLAN OF SUBDIVISION OF LOT 1 IN DP 776401 AND EASEMENTS OVER LOTS 9,23,24 AND 25 SECTION E IN DP 8270	This sheet is for the provision of the following information as required: <ul style="list-style-type: none"> • A schedule of lots and addresses - See 60(c) SSI Regulation 2012 • Statements of intention to create and release affecting interests in accordance with section 88B Conveyancing Act 1919 • Signatures and seals- see 195D Conveyancing Act 1919 • Any information which cannot fit in the appropriate panel of sheet 1 of the administration sheets.
Subdivision Certificate number: <u>SC 2015/0004</u> Date of Endorsement: <u>02/03/2015</u>	

Lot	Street Number	Street Name	Street Type	Locality
100	23	Pacific	Parade	Dee Why
101	16	Sturdee	Parade	Dee Why

Pursuant to Section 88B of the Conveyancing Act 1919
 It is intended to create:

1. Right of Carriageway 3 Wide and Variable Width (B)
2. Right of Access 6 Wide (C)

Signed on behalf of Dee Why Properties Pty Limited ABN 14-156 374 837
 In accordance with Section 127 of the Corporations Act 2001

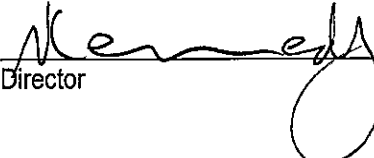

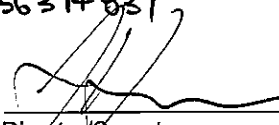
 Director

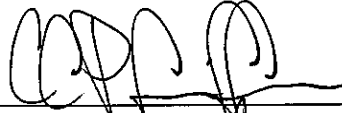
 Director/Secretary

 General Manager/Authorised Officer
 Warringah Council

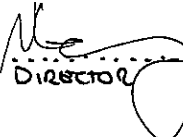
Signed on behalf of ORACLE DEE WHY PTY LIMITED
 In accordance with Section 127 of the Corporations Act 2001 ACN 159 927 269

 Director

 Director

Rik Hart
GENERAL MANAGER

Signed in my presence by
 who is either personally known to me or has satisfied me as to his or her identity, as attorney for National Australia Bank Limited

 Signature of Witness

CAROLINE FITKINER
 Print Full Name of Witness

22-28 KING WILLIAM ST
ADELAIDE SA 5000
 Address of Witness

08 8407 6254
 Business Telephone Number

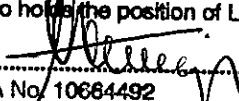
NATIONAL AUSTRALIA BANK LIMITED
 by its Attorney
 who holds the position of Level 3 Attorney

 P/A No. 10664492

If space is insufficient use additional annexure sheet

**Instrument setting out terms of Easements intended to be
 created and Restrictions on the Use of Land or Positive Covenants intended to be created pursuant to
 Section 88B of the Conveyancing Act, 1919.**

Sheet 1 of 2 sheets

PLAN: DP1201083

Plan of Subdivision of Lot 1 in DP 776401
 and Easements over Lot 9, 23, 24 and Lot
 25 Section E in DP 8270 covered by Council
 Subdivision Certificate *SC 2015/0004*
 Dated *02/03/2015*

Full name and address of the owners of the land:

Warringah Council
 725 Pittwater Road
 Dee Why NSW 2099

Dee Why Properties Pty Limited
 Unit 10 56 Buffalo Road
 Gladesville NSW 2111

Part 1 (Creation)

Number of item shown in the intention panel on the plan	Identity of easement, restriction or positive covenant to be created and referred to in the plan.	Burdened lot(s)	Benefited lot(s), bodies or Prescribed Authorities.
1	Right of Carriageway 3 Wide and Variable Width (B)	23/E/8270 9/E/8270	100/1201083 8/E/8270 9/E/8270 23/E/8270 24/E/8270 25/E/8270 101/1201083
2	Right of Access 6 Wide (C)	101/1201083 25/E/8270 24/E/8270 23/E/8270	100/1201083 8/E/8270 9/E/8270 100/1201083 8/E/8270 9/E/8270 100/1201083 8/E/8270 9/E/8270 100/1201083 8/E/8270 9/E/8270

Part 2 (Terms)

TERMS OF RIGHT OF CARRIAGEWAY 3 WIDE AND VARIABLE WIDTH (B) NUMBERED 1 IN THE PLAN

The terms of the Right of Carriageway as set out in the Conveyancing Act 1919 section 181A, Schedule 8, Part 1 are incorporated into this document.

The name of the authority empowered to vary, release or modify the easement numbered 1:

Warringah Council



WARRINGAH COUNCIL

 Authorized Person

PLAN: DP1201083

Plan of Subdivision of Lot 1 in DP 776401 and
Easements over Lot 9, 23, 24 and Lot 25
Section E in DP 8270 covered by Council
Subdivision Certificate ~~SC~~ 2015/0004
Dated 02/03/2015

TERMS OF RIGHT OF ACCESS 6 WIDE (C) NUMBERED 2 IN THE PLAN

The terms of the Right of Access as set out in the Conveyancing Act 1919 section 181A, Schedule 8, Part 14 are incorporated into this document.

The name of the authority empowered to vary, release or modify the easement numbered 2:

Warringah Council

Signed in accordance with Section 127
of the Corporations Act by

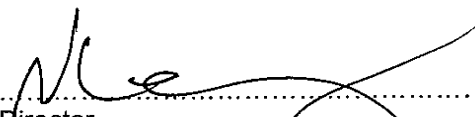

.....
Director
Dee Why Properties Pty Limited
ABN 14 156 374 837

.....
Director/Secretary
Dee Why Properties Pty Limited
ABN 14 156 374 837

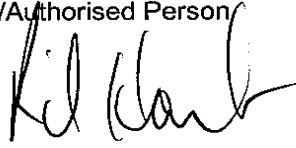
Approved by Warringah Council

.....
General Manager/Authorised Person

Rik Hart
GENERAL MANAGER

Signed on behalf of ~~DBB~~
ORACLE DBS WHY PTY LIMITED ACN 159927269
In accordance with Section 127 of the Corporations Act

.....
DIRECTOR

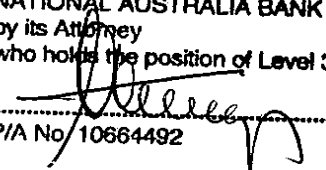

.....
DIRECTOR

Signed in my presence by	NATIONAL AUSTRALIA BANK LIMITED
who is either personally known to me or has satisfied me as to his or her identity, as attorney for National Australia Bank Limited	by its Attorney who holds the position of Level 3 Attorney
 Signature of Witness	 P/A No 10664492
CAROLINE FALKNER Print Full Name of Witness	
22 KING WILLIAM ST ADELAIDE SA 5000 Address of Witness	
Business Hours: Telephone number 08 8407 6254	

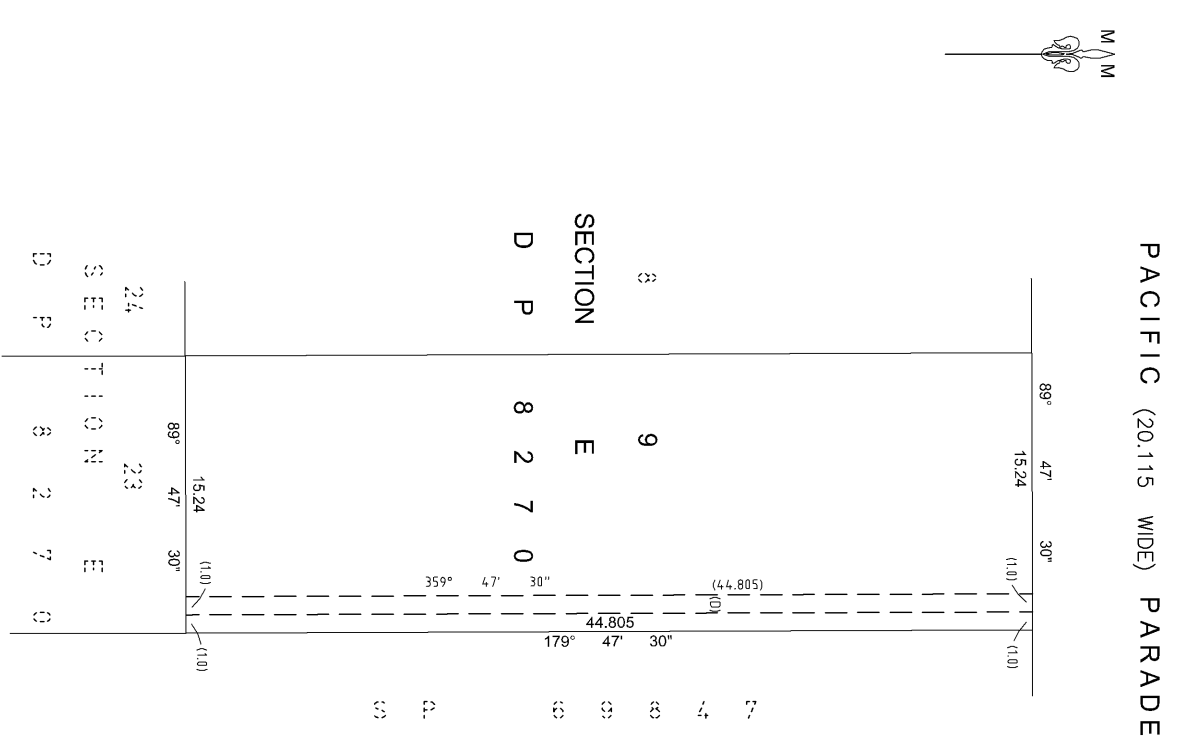

0 10 20 30 40 50 60 70 80 90 100 110 120 130 140 150

(0) EASEMENT TO DRAIN WATER 1 WIDE



Surveyor: CHRISTOPHER PATRICK HILL
 Surveyor's Ref: D2150-DP
 File: 2014AN7100(529).Camp
 Date of Survey: 24th September 2014

PLAN OF EASEMENT OVER LOT 9 SECTION E IN DP8270

LGA: WARRINGAH
 Locality: DEE WHY
 Subdivision No: _____
 Lengths are in metres. Reduction Ratio 1:200

Registered
 9.4.2015

DP1207001

PLAN FORM 6 (2012)

WARNING: Creasing or folding will lead to rejection

ePlan

DEPOSITED PLAN ADMINISTRATION SHEET

Sheet 1 of 2 sheet(s)

<p>Registered:  9.4.2015 Title System: TORRENS Purpose: EASEMENT</p>	<p>Office Use Only</p> <p style="text-align: center; font-size: 24pt;">DP1207001</p> <p>Office Use Only</p>
<p>PLAN OF EASEMENT OVER LOT 9 SECTION E IN DP 8270</p>	<p>LGA: WARRINGAH Locality: DEE WHY Parish: MANLY COVE County: CUMBERLAND</p>
<p>Crown Lands NSW/Western Lands Office Approval</p> <p>I, (Authorised Officer) in approving this plan certify that all necessary approvals in regard to the allocation of the land shown herein have been given.</p> <p>Signature: Date: File Number: Office:</p>	<p style="text-align: center;">Survey Certificate</p> <p>I, CHRISTOPHER PATRICK HILL of PROJECT SURVEYORS PO BOX 4004 MACQUARIE CENTRE NSW 2113 a surveyor registered under the <i>Surveying and Spatial Information Act 2002</i>, certify that:</p> <p>*(a) The land shown in the plan was surveyed in accordance with the <i>Surveying and Spatial Information Regulation 2012</i>, is accurate and the survey was completed on 24 September 2014</p> <p>*(b) The part of the land shown in the plan (*being* excluding) was surveyed in accordance with the <i>Surveying and Spatial Information Regulation 2012</i>, is accurate and the survey was completed on the part not surveyed was compiled in accordance with that Regulation.</p> <p>*(c) The land shown in this plan was compiled in accordance with the <i>Surveying and Spatial Information Regulation 2012</i>.</p> <p>Signature: <i>Chris Hill</i> Dated: <i>17.03.15</i>..... Surveyor ID: 95 Datum Line: 'X' - 'Y' Type: *Urban*<i>Rural</i> The terrain is *Level-Undulating / *Steep-Mountainous.</p> <p>*Strike through if inapplicable. ^Specify the land actually surveyed or specify any land shown in the plan that is not the subject of the survey.</p>
<p style="text-align: center;">Subdivision Certificate</p> <p>I, *Authorised Person/*General Manager/*Accredited Certifier, certify that the provisions of s.109J of the <i>Environmental Planning and Assessment Act 1979</i> have been satisfied in relation to the proposed subdivision, new road or reserve set out herein.</p> <p>Signature: Accreditation number: Consent Authority: Date of endorsement: Subdivision Certificate number: File number:</p> <p>*Strike through if inapplicable.</p>	<p>Plans used in the preparation of survey/compilation. DP 8270 DP 1201083P SP 69487</p> <p style="text-align: right;">If space is insufficient continue on PLAN FORM 6A</p>
<p>Signatures, Seals and Section 88B Statements should appear on PLAN FORM 6A</p>	<p>Surveyor's Reference: D2150-DP File 2014M7100(1529) Comp</p>

PLAN FORM 6A (2012)

WARNING: Creasing or folding will lead to rejection

ePlan

DEPOSITED PLAN ADMINISTRATION SHEET

Sheet 2 of 2 sheet(s)

<p>Office Use Only</p> <p>Registered:  9.4.2015</p> <p>PLAN OF EASEMENT OVER LOT 9 SECTION E IN DP 8270</p> <p>Subdivision Certificate number:</p> <p>Date of Endorsement:</p>	<p>Office Use Only</p> <p style="font-size: 2em; font-weight: bold;">DP1207001</p> <p>This sheet is for the provision of the following information as required:</p> <ul style="list-style-type: none"> • A schedule of lots and addresses - See 60(c) SSI Regulation 2012 • Statements of intention to create and release affecting interests in accordance with section 88B Conveyancing Act 1919 • Signatures and seals- see 195D Conveyancing Act 1919 • Any information which cannot fit in the appropriate panel of sheet 1 of the administration sheets.
--	--

Pursuant to Section 88B of the Conveyancing Act 1919
 It is intended to create:

1. Easement to Drain Water 1 Wide (D)

Signed on behalf of Dee Why Properties Pty Limited ABN 14156 374 837
 In accordance with Section 127 of the Corporations Act 2001



 Director

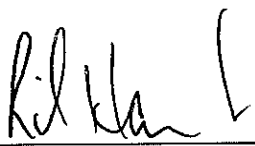

 Director/Secretary

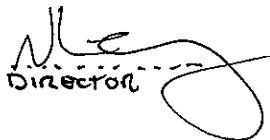
 General Manager/Authorised Officer
 Warringah Shire Council

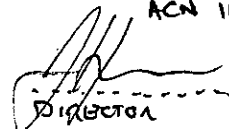
Signed for on behalf of ORACLE DEE WHY PTY LIMITED in accordance with Section 127 of the Corporations Act 2001 ACN 159927269

 Director

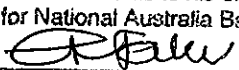
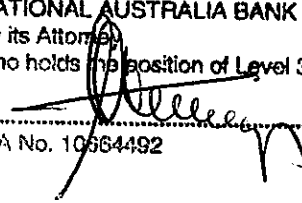
 Director

<p>Signed in my presence by</p> <p>who is either personally known to me or has satisfied me as to his or her identity, as attorney for National Australia Bank Limited</p> <p> Signature of Witness</p> <p>CAROLINE FALKNER Print Full Name of Witness</p> <p>22-KING WILLIAM ST Address of Witness</p> <p>ADELAIDE SA 5000</p> <p>Business Hours: Telephone number 08 84076254</p>	<p>NATIONAL AUSTRALIA BANK LIMITED</p> <p>by its Attorney</p> <p>who holds the position of Level 3 Attorney</p> <p> P/A No. 10664492</p>
---	--

If space is insufficient use additional annexure sheet

Surveyor's Reference: D2150-DP File 2014M7100(1529) Comp

Instrument setting out terms of Easements intended to be created and Restrictions on the Use of Land or Positive Covenants intended to be created pursuant to Section 88B of the Conveyancing Act, 1919.

Sheet 1 of 2 sheets

PLAN: DP1207001

Plan of Easement over
Lot 9 Section E in DP
8270

Full name and address of the owners of the land:

Warringah Council
725 Pittwater Road
Dee Why NSW 2099

Part 1 (Creation)

Number of item shown in the intention panel on the plan	Identity of easement, restriction or positive covenant to be created and referred to in the plan.	Burdened lot(s)	Benefited lot(s), bodies or Prescribed Authorities.
1	Easement to Drain Water 1 Wide (D)	9/E/8270	23/E/8270 24/E/8270 25/E/8270 101/1201083

Part 2 (Terms)

TERMS OF EASEMENT TO DRAIN WATER 1 WIDE (D) NUMBERED 1 IN THE PLAN

The terms of the Easement to Drain Water as set out in the Conveyancing Act 1919 section 181A, Schedule 8, Part 3 are incorporated into this document.

The name of the authority empowered to vary, release or modify the easement numbered 1:

Warringah Council



PLAN: DP1207001

Plan of Easement over Lot 9 Section E in DP 8270

Signed in accordance with Section 127 of the Corporations Act by

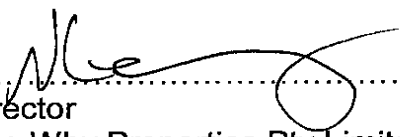

.....
Director
Dee Why Properties Pty Limited
ABN 14 156 374 837

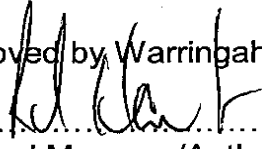

.....
Director/Secretary
Dee Why Properties Pty Limited
ABN 14 156 374 837

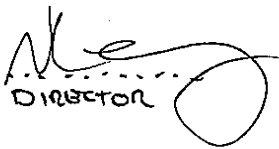
Signed for on behalf of ORACLE DEE WHY PTY LIMITED in accordance with Section 127 of the Corporations Act 2011 ACN 159927269

Approved by Warringah Council

.....
General Manager/Authorised Person

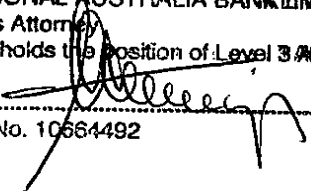
.....
Director



.....
Director

Signed in my presence by	NATIONAL AUSTRALIA BANK LIMITED
who is either personally known to me or has satisfied me as to his or her identity, as attorney for National Australia Bank Limited	by its Attorney who holds the position of Level 3 Attorney
 Signature of Witness	 P/A No. 10564492
CAROLINE FALKNER Print Full Name of Witness	
22 KING WILLIAM ST Address of Witness	
ADELIDE SA 5000 Business Name: Telephone number 08 8401 6254	

REGISTERED  9.4.2015

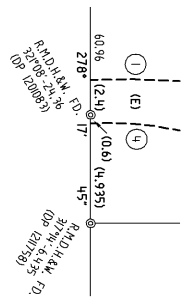

DIAGRAM
NOT TO SCALE



STURDEE PARADE

PACIFIC

(2015 WIDE)

PARADE

(2015 WIDE)

MARK	M.G.A. CO-ORDINATES		CLASS	ORDER	METHOD	ORIGIN
	EASTING	NORTHING				
P.M. 2197	340 911.922	6 263 524.661	B	2	FROM SCINS	FOUND
P.M. 2845	341 018.361	6 263 647.402	B	2	FROM SCINS	FOUND
P.M. 55232	341 636.443	6 263 666.228	B	2	FROM SCINS	FOUND

M.G.A. CO-ORDINATES ADOPTED FROM SCINS AS AT 01-03-2016
COMBINED SCALE FACTOR = 0.999904 ZONE 56

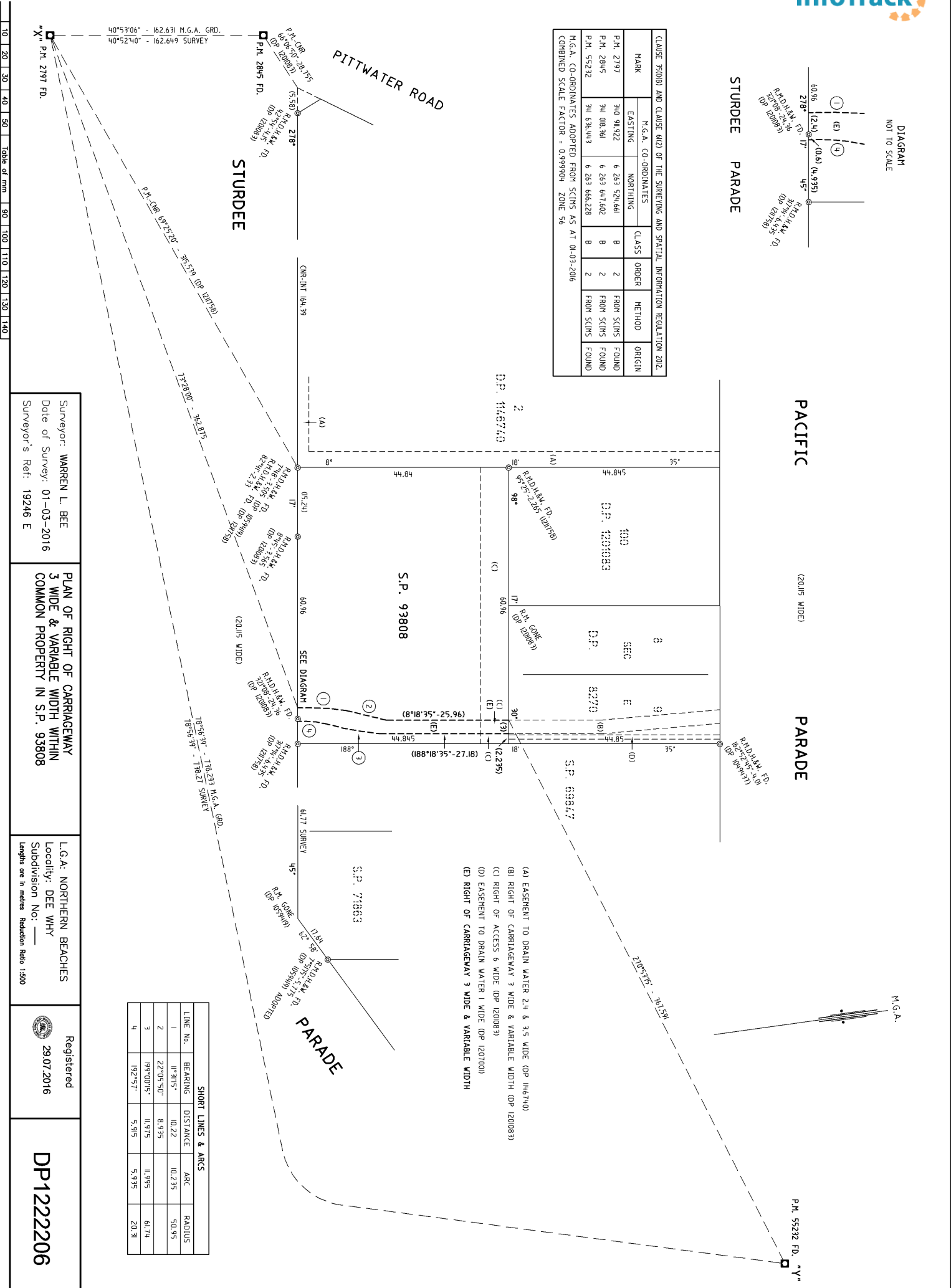

- (A) EASEMENT TO DRAIN WATER 2.4 & 3.5 WIDE (DP 146740)
- (B) RIGHT OF CARRIAGEWAY 3 WIDE & VARIABLE WIDTH (DP 120083)
- (C) RIGHT OF ACCESS 6 WIDE (DP 120083)
- (D) EASEMENT TO DRAIN WATER 1 WIDE (DP 120700)
- (E) RIGHT OF CARRIAGEWAY 3 WIDE & VARIABLE WIDTH

LINE No.	BEARING	DISTANCE	ARC	RADIUS
1	11°31'15"	10.22	10.235	50.95
2	22°05'50"	8.935	11.995	61.74
3	169°00'15"	11.975	5.935	20.31
4	192°55'7"	5.915	5.935	20.31

Surveyor: WARREN L. BEE
Date of Survey: 01-03-2016
Surveyor's Ref: 19246 E

PLAN OF RIGHT OF CARRIAGEWAY
3 WIDE & VARIABLE WIDTH WITHIN
COMMON PROPERTY IN S.P. 93808

L.G.A: NORTHERN BEACHES
Locality: DEE WHY
Subdivision No: _____
Lengths are in metres Reduction Ratio 1:500

Registered
29.07.2016

DP1222206

10	20	30	40	50	60	70	80	90	100	110	120	130	140
----	----	----	----	----	----	----	----	----	-----	-----	-----	-----	-----

Table of mm

DEPOSITED PLAN ADMINISTRATION SHEET

Sheet 1 of 2 sheet(s)

<p>Registered:  29.07.2016 Title System: TORRENS Purpose: EASEMENT</p>	<p>Office Use Only</p> <p style="text-align: center; font-size: 2em;">DP122206</p>
<p>PLAN OF RIGHT OF CARRIAGEWAY 3 WIDE & VARIABLE WIDTH WITHIN LOT 1 IN DP 1211758 COMMON PROPERTY IN SP 93808.</p>	<p>LGA: Warringah Northern Beaches. Locality: Dee Why Parish: Manly Cove County: Cumberland</p>
<p>Crown Lands NSW/Western Lands Office Approval</p> <p>I, (Authorised Officer) in approving this plan certify that all necessary approvals in regard to the allocation of the land shown herein have been given.</p> <p>Signature: Date: File Number: Office:</p>	<p style="text-align: center;">Survey Certificate</p> <p>I, Warren L Bee..... of PO Box 330 Forestville NSW 2087..... a surveyor registered under the <i>Surveying and Spatial Information Act 2002</i>, certify that:</p> <p>*(a) The land shown in the plan was surveyed in accordance with the <i>Surveying and Spatial Information Regulation 2012</i>, is accurate and the survey was completed on 1/3/2016</p> <p>*(b) The part of the land shown in the plan (*being/*excluding ^.....) was surveyed in accordance with the <i>Surveying and Spatial Information Regulation 2012</i>, is accurate and the survey was completed on..... the part not surveyed was compiled in accordance with that Regulation.</p> <p>*(c) The land shown in this plan was compiled in accordance with the <i>Surveying and Spatial Information Regulation 2012</i>.</p> <p>Signature:  Dated: 1/3/2016 Surveyor ID: 448 Datum Line: X-Y..... Type: *Urban/*Rural The terrain is *Level-Undulating / *Steep-Mountainous.</p> <p>*Strike through if inapplicable. ^Specify the land actually surveyed or specify any land shown in the plan that is not the subject of the survey.</p>
<p style="text-align: center;">Subdivision Certificate</p> <p>I, *Authorised Person/*General Manager/*Accredited Certifier, certify that the provisions of s.109J of the <i>Environmental Planning and Assessment Act 1979</i> have been satisfied in relation to the proposed subdivision, new road or reserve set out herein.</p> <p>Signature: Accreditation number: Consent Authority: Date of endorsement: Subdivision Certificate number: File number:</p> <p>*Strike through if inapplicable.</p>	<p>Statements of intention to dedicate public roads create public reserves and drainage reserves, acquire/resume land.</p> <p>Plans used in the preparation of survey/compilation. DP 1211758</p> <p style="text-align: center;">If space is insufficient continue on PLAN FORM 6A</p> <p>Signatures, Seals and Section 88B Statements should appear on PLAN FORM 6A</p> <p>Surveyor's Reference: 19246E</p>

DEPOSITED PLAN ADMINISTRATION SHEET

Sheet 2 of ⁴2 sheet(s)

Office Use Only

Office Use Only

Registered:  29.07.2016

DP122206

PLAN OF RIGHT OF CARRIAGEWAY 3 WIDE & VARIABLE WIDTH WITHIN ~~LOT 1 IN DP 1211758~~ COMMON PROPERTY IN SP 93808.

- This sheet is for the provision of the following information as required:
- A schedule of lots and addresses - See 60(c) SSI Regulation 2012
 - Statements of intention to create and release affecting interests in accordance with section 88B Conveyancing Act 1919
 - Signatures and seals- see 195D Conveyancing Act 1919
 - Any information which cannot fit in the appropriate panel of sheet 1 of the administration sheets.

Subdivision Certificate number:

Date of Endorsement:

Pursuant to Section 88B of the Conveyancy Act 1919 it is intended to create :-

- 1) Right of Carriageway 3 metres wide & variable width

To Release :-

- 1) Right of Carriageway 3 metres wide & variable width created by DP 1201083

~~Mortgage under Mortgage No. A3597716~~

Signed at ~~Dee~~ this ~~6th~~ day of

~~April~~ ~~Why~~ 2016 for National

Australia Bank Limited ABN 12 004 044 937

by

its duly appointed Attorney under Power of Attorney No. 39 Book 4512

~~16 SPD Pty Ltd~~
~~ACN 601 389 712~~

~~Charles McInerney~~
~~Sec Dir Sec~~

Level

Attorney

SIMON KELLY
SENIOR BUSINESS
BANKING MANAGER

Witness/Bank Officer

BENJAMYN STRINGER
ASSOCIATE

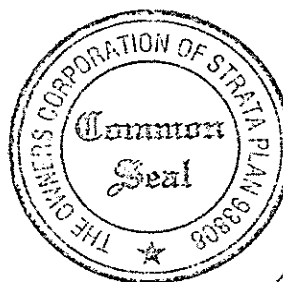

c/- 1, 818 Pittwater Road

DEE WHY 2099

MICHELLE DUNPHY
- STRATA MANAGER

If space is insufficient use additional annexure sheet

Surveyor's Reference: 19246E

PLAN FORM 6A (2012)

WARNING: Creasing or folding will lead to rejection

ePlan

DEPOSITED PLAN ADMINISTRATION SHEET

Sheet 3 of 4 sheet(s)

<p>Registered:  29.07.2016</p> <p>Office Use Only</p>	<p>Office Use Only</p> <p style="font-size: 2em; text-align: center;">DP1222206</p>
<p>PLAN OF RIGHT OF CARRIAGEWAY 3 WIDE & VARIABLE WIDTH WITHIN COMMON PROPERTY IN SP93808</p>	<p>This sheet is for the provision of the following information as required:</p> <ul style="list-style-type: none"> • A schedule of lots and addresses - See 60(c) <i>SSI Regulation 2012</i> • Statements of intention to create and release affecting interests in accordance with section 88B <i>Conveyancing Act 1919</i> • Signatures and seals- see 195D <i>Conveyancing Act 1919</i> • Any information which cannot fit in the appropriate panel of sheet 1 of the administration sheets.
<p>Subdivision Certificate number:</p> <p>Date of Endorsement:</p>	

Approved Form 10

Certificate re Initial Period

- (1) The Owners - Strata Plan No. 93808 hereby certifies that in respect of their strata scheme that;
- ~~A~~ ~~*(a) The local council or accredited certifier issued a strata certificate consenting to a subdivision on~~
~~^~~
- ~~M~~ ~~*(b) The local council or accredited certifier issued a strata certificate consenting to a notice of~~
~~conversion on~~ ~~^~~
- ~~A~~ ~~*(c) The owners corporation issued a certificate indicating the passing of a special resolution~~
 authorising the execution of a dealing on 21-7-16
 and,
- ~~M~~ ~~*(2) The initial period expired before the above date.~~
- *(3) At the above date the original proprietor owned all of the lots in the strata scheme and any purchaser under an exchanged contract for purchase of a lot in the strata scheme consented to any plan or dealing that is being lodged along with this certificate.

The common seal of the Owners - Strata Plan No 93808 was hereunto affixed on 21-7-16 in the presence of MICHELE DUNPHY being the person(s) authorised by section 238 Strata Schemes Management Act 1996 to attest the affixing of the seal.

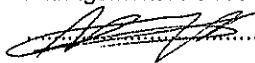

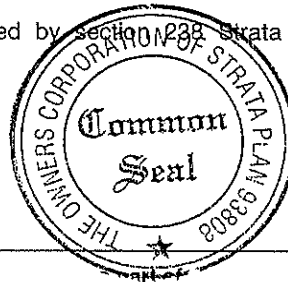

* Strike through if inapplicable.
 ^ Insert appropriate date

If space is insufficient use additional annexure sheet

Surveyor's Reference: 19246E

PLAN FORM 6A (2012)

WARNING: Creasing or folding will lead to rejection

ePlan

DEPOSITED PLAN ADMINISTRATION SHEET

Sheet 4 of 4 sheet(s)

Registered:  29.07.2016 Office Use Only

Office Use Only

DP1222206

PLAN OF RIGHT OF CARRIAGEWAY 3 WIDE & VARIABLE WIDTH WITHIN COMMON PROPERTY IN SP93808

- This sheet is for the provision of the following information as required:
- A schedule of lots and addresses - See 60(c) *SSI Regulation 2012*
 - Statements of intention to create and release affecting interests in accordance with section 88B *Conveyancing Act 1919*
 - Signatures and seals- see 195D *Conveyancing Act 1919*
 - Any information which cannot fit in the appropriate panel of sheet 1 of the administration sheets.

Subdivision Certificate number:
Date of Endorsement:

Approved Form 23

Attestation

The common seal of the Owners - Strata Plan No 93808 was hereunto affixed on 21-7-16 in the presence of MICHELLE DUNPHY being the person (s) authorised by s. 238 Strata Schemes Management Act 1996 to attest the affixing of the seal.

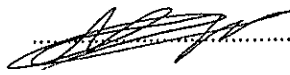
.....
.....

^ Insert appropriate date

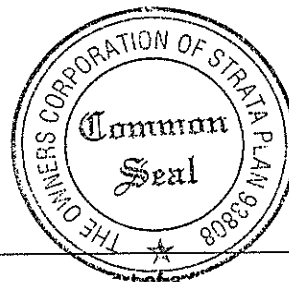

If space is insufficient use additional annexure sheet

Surveyor's Reference: 19246E

INSTRUMENT SETTING OUT TERMS OF EASEMENTS INTENDED TO BE CREATED OR RELEASED PURSUANT TO SECTION 88B OF THE CONVEYANCING ACT 1919

Lengths are in metres

Sheet 1 of ⁶ sheets

DP1222206

Plan of Right of Carriageway 3 wide & variable width within Lot 1 in DP ~~1211758~~
 Dated: common property in SP.93808

Full name and address of proprietors of land:

16 SPD Pty Ltd
 ACN 601 384 712
 1 Green Street
 BROOKVALE NSW 2100

PART 1 CREATION

Number of item shown in the intention panel of the plan	Identity of easement, profit à prendre, restriction or positive covenant to be created and referred to in the plan	Burdened lot(s) or parcel(s)	Benefited lot(s), road(s), bodies or Prescribed Authorities
1	Right of Carriageway 3 wide & variable width	1/1211758 CP/SP93808	100/1201083 8/E/8270 9/E/8270

PART 1 RELEASE

Number of item shown in the intention panel of the plan	Identity of easement, profit à prendre, restriction or positive covenant to be created and referred to in the plan	Burdened lot(s) or parcel(s)	Benefited lot(s), road(s), bodies or Prescribed Authorities
1	Right of Carriageway 3 metres wide & variable width created by DP1201083	1/1211758 CP/SP93808	100/1201083 8/E/8270 9/E/8270

WARRINGAH COUNCIL

 Authorised Person

Lengths are in metres

Sheet 2 of ⁶/₃ sheets

DP1222206

Plan of Right of Carriageway 3 wide &
variable width within ~~Lot 1 in DP 1211758~~
Dated: common property in
SP 93808

~~Executed by 16 SPD Pty Ltd (ACN 601 384 712) by:~~

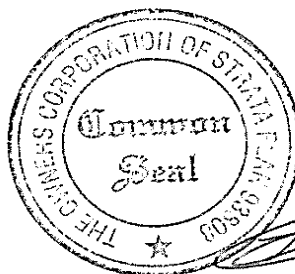

.....
~~Solo Director and Secretary~~

~~Charles Maloney~~
.....
Name (BLOCK LETTERS)

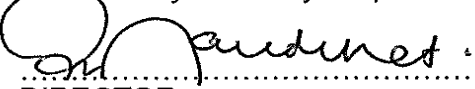

Michelle Dunphy

MICHELLE DUNPHY
- STRATA MANAGER.

Executed by Dee Why Properties No 2 Pty Limited (ACN 166 135 422) by

.....
DIRECTOR

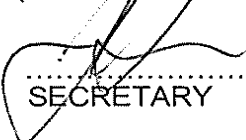
BRUCE W. BAUDINET
.....
Name (BLOCK LETTERS)

.....
SECRETARY

JUSTIN J. KUCK
.....
Name (BLOCK LETTERS)

WARRINGAH COUNCIL

.....
Authorized Person

Lengths are in metres



Sheet 3 of ⁶/₃ sheets

DP1222206

Plan of Right of Carriageway 3 wide & variable width within ~~lot 1 in DP 1211758~~ common property in SP 93808.

MORTGAGEES CONSENT

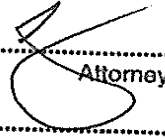
Mortgagee under Mortgage No. 45 59 71 16
Signed at ~~Dee~~ this ~~6th~~ day of ~~April~~ ^{wh7} 20 ~~16~~ for National Australia Bank Limited ABN 12 004 044 937
by
its duly appointed Attorney under Power of Attorney No. 39 Book 4512

.....
Level  Attorney
.....
Witness/Bank Officer 

SIMON KELLY
SENIOR BUSINESS
BANKING MANAGER

BENJAMYN STRINGER
ASSOCIATE

c/- 1, 818 Pittwater Road
DEE WHY 2099

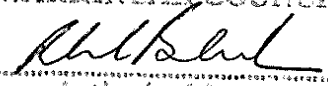
WARRINGAH COUNCIL

.....
Authorized Person

DP1222206

Approved Form 9

Certificate of Owners Corporation

The Owners - Strata Plan No. 93808 certifies that:

- (1) On 27.7.16 it passed a special resolution agreeing to the execution of the dealing or plan
* DP1222206 pursuant to section 28(4) Strata Schemes
(Freehold Development) Act 1973 or section 32(4) Strata Schemes (Leasehold Development) Act
1986;
- (2) The requirements of section 28(3)(a)(ii) Strata Schemes (Freehold Development) Act 1973 or
section 32(3)(a)(ii) Strata Schemes (Leasehold Development) Act 1986 have been complied with
in respect of the said dealing or plan.

The common seal of the Owners - Strata Plan No 93808... was hereunto affixed on 27/7/16 in
the presence of MICHELLE DUNPHY being the person (s) authorised by section 238 Strata
Schemes Management Act 1996 to attest the affixing of the seal.

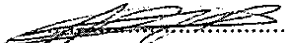
.....
MICHELLE DUNPHY.....

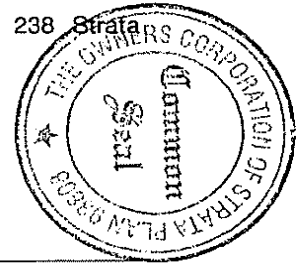

* Set out sufficient particulars to identify positively the transfer or lease to which the certificate relates.

^ Insert the applicable date.

DP1222206

Approved Form 10

Certificate re Initial Period

(1) The Owners - Strata Plan No. 93808 hereby certifies that in respect of their strata scheme that;

~~M~~ ~~*(a) The local council or accredited certifier issued a strata certificate consenting to a subdivision on~~
~~^.....~~

~~M~~ ~~*(b) The local council or accredited certifier issued a strata certificate consenting to a notice of~~
~~conversion on ^.....~~

~~M~~ ~~*(c) The owners corporation issued a certificate indicating the passing of a special resolution~~
authorising the execution of a dealing on ^21-7-16
and,

~~M~~ ~~*(2) The initial period expired before the above date.~~

~~*(3) At the above date the original proprietor owned all of the lots in the strata scheme and any purchaser under an exchanged contract for purchase of a lot in the strata scheme consented to any plan or dealing that is being lodged along with this certificate.~~

The common seal of the Owners - Strata Plan No 93808 was hereunto affixed on ^21-7-16 in the presence of MICHELLE DUNPHY being the person(s) authorised by section 238 Strata Schemes Management Act 1996 to attest the affixing of the seal.

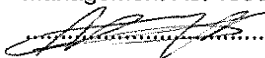
.....



* Strike through if inapplicable.

^ Insert appropriate date

Text below this line is part of the instructions and should not be reproduced as part of a final document.

1. This form must be provided in its entirety as shown above.
2. Any inapplicable parts should be struck through.
3. This is the certificate referred to in
 - Sections 9(3)(d), 9(3A), 13(2)(b) Strata Schemes (Freehold Development) Act 1973
 - Sections 11(2)(c), 9(2A)(a), 16(2)(b) Strata Schemes (Leasehold Development) Act 1986
4. This certificate is required to accompany any document which proposes action not permitted during the initial period and when the common property title does not have a notification indicating the initial period has been expired.

DP1222206

Approved Form 23

Attestation

The common seal of the Owners - Strata Plan No 93808 was hereunto affixed on 21-7-16 in the presence of MICHELLE DUNPHY being the person (s) authorised by s. 238 Strata Schemes Management Act 1996 to attest the affixing of the seal.

.....
.....

^ Insert appropriate date

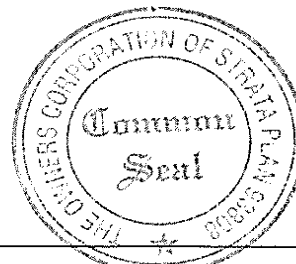

Text below this line is part of the instructions and should not be reproduced as part of a final document.

1. This form must be provided in its entirety as shown above.
2. This attestation is required when the seal of the owners corporation is affixed in accordance with section 238 Strata Schemes Management Act 1996

Updated April 2009

REGISTERED



29.07.2016



Form: 01TG
Release: 3-1

TRANSFER GRANTING EASEMENT

New South Wales
Real Property Act 1900

AK630238X

Plan fee paid

PRIVACY NOTE: Section 31B of the Real Property Act 1900 (RP Act) authorises the Registrar General to collect the information required by this form for the establishment and maintenance of the Real Property Act Register. Section 96B RP Act requires that the Register is made available to any person for search upon payment of a fee, if any.

(A) **TORRENS TITLE**

Servient Tenement CP/SP93808	Dominant Tenement 8/E/8270 9/E/8270 100/1201083
-------------------------------------	--

(B) **LODGED BY**

Document Collection Box 1W	Name, Address or DX, Telephone, and Customer Account Number if any <i>Andrews & Holm Lawyers</i> <i>PO Box 66 QVB, Sydney NSW 1230</i> <i>9261 2704</i> Reference: <i>Pacific Parade Manly</i>	CODE TG
-----------------------------------	--	-----------------------

(C) **TRANSFEROR**

The Owners - Strata Plan no. 93808

(D)

The transferor acknowledges receipt of the consideration of \$ 1.00
and transfers and grants—

(E) **DESCRIPTION OF EASEMENT**

Easement for Services 1 & 3.7 wide
(see Annexure A)

out of the servient tenement and appurtenant to the dominant tenement.

(F)

Encumbrances (if applicable):

(G) **TRANSFeree**

Dee Why Properties No. 2 Pty Ltd ACN 166 135 422

DATE 25 July 2016

(H) Certified correct for the purposes of the Real Property Act 1900 and executed on behalf of the company named below by the authorised person(s) whose signature(s) appear(s) below pursuant to the authority specified.

Company: The Owners - Strata Plan No. 93808
Authority: Section 238 of the Strata Schemes Management Act 1996

Signature of authorised person:
Name of authorised person: MICHELLE DUNPHY
Office held: Chairman Strata Manager

Signature of authorised person:
Name of authorised person:
Office held: Secretary

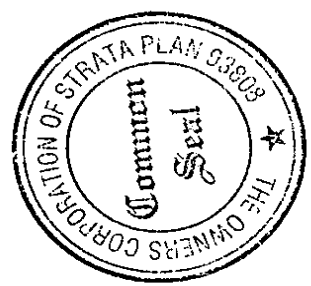

Certified correct for the purposes of the Real Property Act 1900 on behalf of the transferee by the person whose signature appears below.

Signature:
Signatory's name: Andrew Mutton
Signatory's capacity: solicitor

CT's Produced by 124E 26/7/16
Dominant tenements

C819392

PLAN

ANNEXURE "A"

OF PROPOSED EASEMENT FOR SERVICES 1 & 3.7 WIDE WITHIN
 THE COMMON PROPERTY OF S.P. 93808, L.G.A. NORTHERN BEACHES
 RATIO 1:500

PACIFIC

PARADE

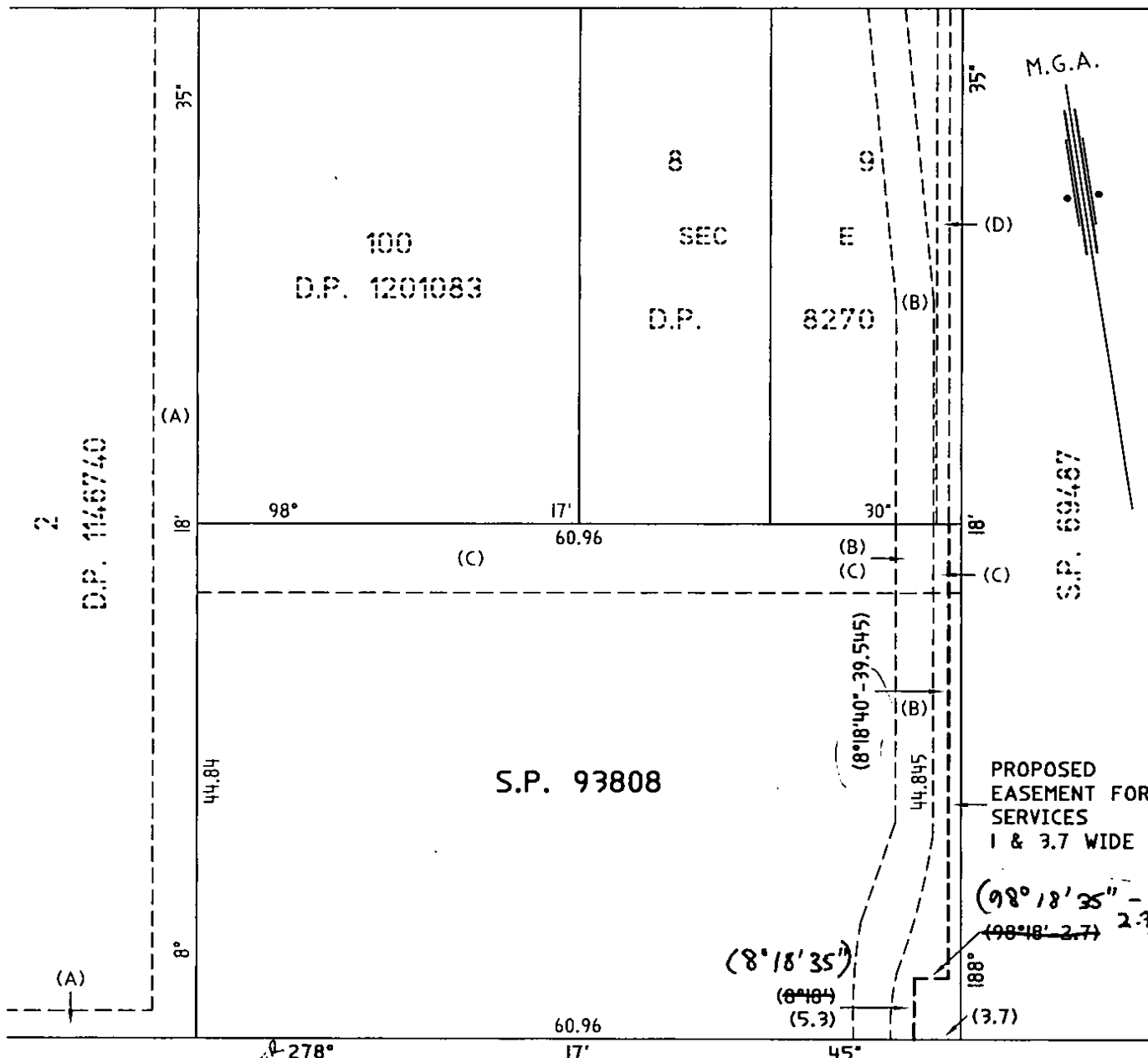

AM AM Authorised to amend Andrew Mutton 3/08/2016

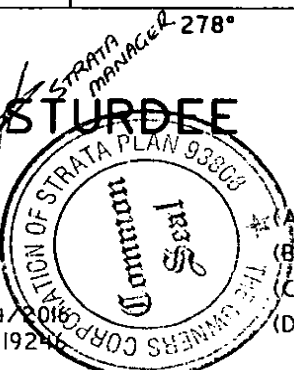

- (A) EASEMENT TO DRAIN WATER 2.4 & 3.5 WIDE (DP 1146740)
- (B) RIGHT OF CARRIAGEWAY 3 WIDE & VARIABLE WIDTH (DP 1222206)
- (C) RIGHT OF ACCESS 6 WIDE (DP 1201083)
- (D) EASEMENT TO DRAIN WATER 1 WIDE (DP 1207001)

DATE: 28/04/2016
 REFERENCE: 19246

FILM WITH AK630238

COPY

Approved Form 23

Attestation

The common seal of the Owners - Strata Plan No 93808 was hereunto affixed on 21-7-16 in the presence of MICHELLE DUNPHY being the person (s) authorised by s. 238 Strata Schemes Management Act 1996 to attest the affixing of the seal.

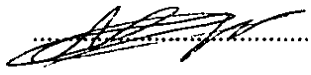
.....
.....



^ Insert appropriate date

Text below this line is part of the instructions and should not be reproduced as part of a final document.

1. This form must be provided in its entirety as shown above.
2. This attestation is required when the seal of the owners corporation is affixed in accordance with section 238 Strata Schemes Management Act 1996

FILM WITH AK 630238
COPY

Approved Form 10

Certificate re Initial Period

(1) The Owners - Strata Plan No. 93808... hereby certifies that in respect of their strata scheme that;

~~^~~ *~~(a)~~ The local council or accredited certifier issued a strata certificate consenting to a subdivision on ^.....,

~~M~~ *~~(b)~~ The local council or accredited certifier issued a strata certificate consenting to a notice of conversion on ^.....,

~~M~~ *~~(c)~~ The owners corporation issued a certificate indicating the passing of a special resolution authorising the execution of a dealing on ^21-7-16 and,

~~M~~ *~~(2)~~ The initial period expired before the above date.

*~~(3)~~ At the above date the original proprietor owned all of the lots in the strata scheme and any purchaser under an exchanged contract for purchase of a lot in the strata scheme consented to any plan or dealing that is being lodged along with this certificate.

The common seal of the Owners - Strata Plan No 93808... was hereunto affixed on ^21-7-16 in the presence of MICHELLE DUNPHY... being the person(s) authorised by section 208 Strata Schemes Management Act 1996 to attest the affixing of the seal.

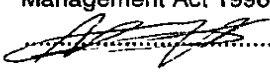
.....



* Strike through if Inapplicable.
^ Insert appropriate date

Text below this line is part of the instructions and should not be reproduced as part of a final document.

1. This form must be provided in it entirety as shown above.
2. Any inapplicable parts should be struck through.
3. This is the certificate referred to in
 - Sections 9(3)(d), 9(3A), 13(2)(b) Strata Schemes (Freehold Development) Act 1973
 - Sections 11(2)(c), 9(2A)(a), 16(2)(b) Strata Schemes (Leasehold Development) Act 1986
4. This certificate is required to accompany any document which proposes action not permitted during the initial period and when the common property title does not have a notification indicating the initial period has been expired.

FILM WITH

Approved Form 9

Certificate of Owners Corporation

The Owners - Strata Plan No. 93808... certifies that:

- (1) On ^27-7-16 it passed a special resolution agreeing to the execution of the dealing or plan * AK630238 pursuant to section 28(4) Strata Schemes (Freehold Development) Act 1973 or section 32(4) Strata Schemes (Leasehold Development) Act 1986;
- (2) The requirements of section 28(3)(a)(ii) Strata Schemes (Freehold Development) Act 1973 or section 32(3)(a)(ii) Strata Schemes (Leasehold Development) Act 1986 have been complied with in respect of the said dealing or plan.

The common seal of the Owners - Strata Plan No 93808... was hereunto affixed on ^27-7-16 in the presence of MICHELLE DUNPHY..... being the person (s) authorised by section 238 Strata Schemes Management Act 1996 to attest the affixing of the seal.

[Handwritten Signature]

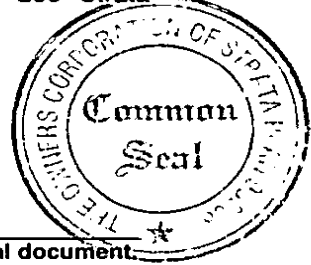

* Set out sufficient particulars to identify positively the transfer or lease to which the certificate relates.
^ Insert the applicable date.

Text below this line is part of the instructions and should not be reproduced as part of a final document.

- 1. This form must be provided in its entirety as shown above.
- 2. Any inapplicable parts should be struck through.
- 3. This is the certificate referred to in;
 - Section 28(4) Strata Schemes (Freehold Development) Act 1973
 - Section 32(4) Strata Schemes (Leasehold Development) Act 1986
- 4. This certificate is required to accompany a dealing including a plan which divests an owners corporation's interest in common property. This would include but not be limited to:
 - A transfer or lease of part of the common property;
 - A creation of an easement which burdens common property;
 - A release of an easement which benefits common property;
 - A plan over common property which dedicates public road, or creates a public or drainage reserve.

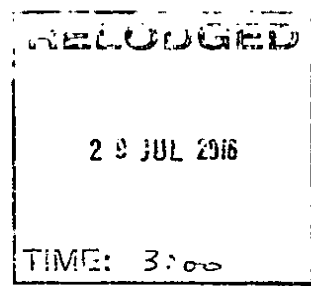

FILM WITH AK630238



Bee & Lethbridge

Quality Surveying & Development Solutions

Our ref: 19246 let5

The Registrar General
Land & Property Information
1 Prince Albert Road
SYDNEY NSW 2000

3 August 2016

Dear Sir,

Re: **AK 630238**

I, Warren Llewelyn Bee, authorise the use of Certificate of Title CP/SP 93008 for registration of Transfer Granting Easement numbered AK 630238.

Yours faithfully

Warren Bee
REGISTERED SURVEYOR

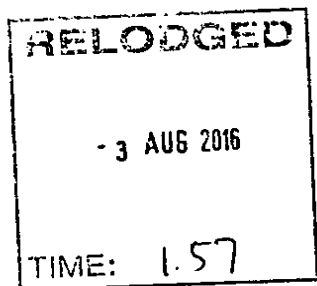

www.beeleth.com.au

Bee & Lethbridge Pty Ltd
Suite 2, 14 Storkey Street,
PO Box. 330, Forestville, NSW 2087
Phone: 9451 6757 Fax: 9975 3535



Form: 13RPA
Release: 3-1

**RESTRICTION ON
USE OF LAND B'
PRESCRIBED AUTH**
New South Wales



AM709465Y

Section 88E(3) Conveyancing Act 1919

PRIVACY NOTE: Section 31B of the Real Property Act 1900 (RP Act) authorises the Registrar General to collect the information required by this form for the establishment and maintenance of the Real Property Act Register. Section 96B RP Act requires that the Register is made available to any person for search upon payment of a fee, if any.

(A) **TORRENS TITLE**

1/1231319

(B) **LODGED BY**

Document Collection Box <i>W</i>	Name, Address or DX, Telephone, and Customer Account Number if any <i>Anders & Holm Lawyers PO Box 66 QVB Sydney NSW 1230</i>	CODE RV
	Reference: <i>A2M</i>	

(C) **REGISTERED PROPRIETOR**

Of the above land
Dee Why Properties No 2 Pty Limited ACN 166 135 422

(D) **LESSEE MORTGAGEE OR CHARGE**

Of the above land agreeing to be bound by this restriction		
Nature of Interest	Number of Instrument	Name
Mortgage	AJ994432	National Australia Bank

(E) **PRESCRIBED AUTHORITY**

Within the meaning of section 88E(1) of the Conveyancing Act 1919
Northern Beaches Council

(F) The prescribed authority having imposed on the above land a restriction in the terms set out in annexure **A** hereto applies to have it recorded in the Register and certifies this application correct for the purposes of the Real Property Act 1900.

DATE *6 September 2017*

(G) I certify that an authorised officer of the prescribed authority who is personally known to me or as to whose identity I am otherwise satisfied signed this application in my presence.

Signature of witness: *[Signature]*
Name of witness: *GERAINT BREESE*
Address of witness: *40 NORTHERN BEACHES COUNCIL
725 PITTWATER RD DEE WHY*

Signature of authorised officer: *[Signature]*
Name of authorised officer: *PAUL DAVID*
Position of authorised officer: *SENIOR DEVELOPMENT ENGINEER*

Certified correct for the purposes of the Real Property Act 1900 and executed on behalf of the company named below by the authorised person(s) whose signature(s) appear(s) below pursuant to the authority specified.

Company: Dee Why Properties No 2 Pty Limited ACN 166 135 422
Authority: section 127 of the Corporations Act 2001

Signature of authorised person: *[Signature]*
Name of authorised person: **NICHOLAS CHARLES HAMILTON KENNEDY**
Office held: **DIRECTOR**

Signature of authorised person: *[Signature]*
Name of authorised person: **JUSTIN JOHN KUCIC**
Office held: **COMPANY SECRETARY**

(H) The mortgagee under mortgage No. AJ994432 agrees to be bound by this restriction. I certify that the mortgagor, who is personally known to me or as to whose identity I am otherwise satisfied, signed this application in my presence.

Signature of witness: *[Signature]*
Name of witness: *JUSTIN KUCIC*
Address of witness: *59 ELTHAM ST CLARESVILLE NSW*

Signature of mortgagee: *[Signature]*
RACHEL TWEEDY
Associate Director
NAB Corporate Property NSW

SIGNED SEALED AND DELIVERED for and on behalf of NATIONAL AUSTRALIA BANK LIMITED ABN 12 004 044 937 by its Attorney who holds the position of Level 2 Attorney under Power of Attorney Registered No 39 Book 4512 in the presence of:

Annexure "A"

Terms of Restriction on the Use of Land

The registered proprietors covenant with the Northern Beaches Council (Council) that they will not:

- I. Do any act, matter or thing which would prevent the structure and works from operating in an efficient manner.
- II. Make any alterations or additions to the structure and works or allow any development within the meaning of the Environmental Planning and Assessment Act 1979 to encroach upon the structure and works without the express written consent of the authority.
- III. This covenant shall bind all persons who claim under the registered proprietors as stipulated in section 88E(5) of the Act.

For the purposes of this covenant:

Structure and Works shall mean the on-site stormwater detention system constructed on the land as detailed on plans approved by Council No DA2014/1093 including all gutters, pipes, drains, walls, kerbs, pits, grates, tanks, chambers, basins and surfaces designed to temporarily detain stormwater on the land.

The Act means the Conveyancing Act 1919.

NAME OF AUTHORITY EMPOWERED TO RELEASE, VARY OR MODIFY THE RESTRICTION REFERRED TO:

NORTHERN BEACHES COUNCIL

NORTHERN BEACHES COUNCIL by its delegate pursuant to S.377 Local Government Act 1993.



.....

Signature of delegate

PAUL DAVID

.....

Name of delegate

I certify that I am an eligible witness and that the delegate signed in my presence



Signature of Witness

GERAINT BREEZE

Name of Witness

c/o NORTHERN BEACHES COUNCIL
725 PITTWATER RD. DEE WHY

Address of Witness

NICHOLAS CHARLES
HAMILTON KENNEDY
JUSTIN JOHN KUCIC

Form: 13PC
Release: 3:1

POSITIVE COVENA
New South Wales
Section 88E(3) Conveyancing Act



AM709466W

PRIVACY NOTE: Section 31B of the Real Property Act 1900 (RP Act) authorises th
by this form for the establishment and maintenance of the Real Propert
the Register is made available to any person for search upon payment of a fee, i.

(A) **TORRENS TITLE** 1/1231319

(B) **LODGED BY**

Document Collection Box <i>lw</i>	Name, Address or DX, Telephone, and Customer Account Number if any <i>Andrews & Hdm Lawyers PO Box 66 QVB Sydney NSW 1230 ph 9261 2709</i>		CODE PC
	Reference: A2M		

(C) **REGISTERED PROPRIETOR**
Of the above land
Dee Why Properties No 2 Pty Limited
ACN 166 135 422

(D) **LESSEE MORTGAGEE or CHARGE**

Of the above land agreeing to be bound by this positive covenant		
Nature of Interest	Number of Instrument	Name
Mortgage	AJ994432	National Australia Bank

(E) **PRESCRIBED AUTHORITY**
Within the meaning of section 88E(1) of the Conveyancing Act 1919
Northern Beaches Council

(F) The prescribed authority having imposed on the above land a positive covenant in the terms set out in annexure A hereto applies to have it recorded in the Register and certifies this application correct for the purposes of the Real Property Act 1900.

DATE 6 September 2017

(G) **Execution by the prescribed authority**
I certify that an authorised officer of the prescribed authority who is personally known to me or as to whose identity I am otherwise satisfied signed this application in my presence.

Signature of witness: <i>Geraint Breeze</i>	Signature of authorised officer: <i>Paul David</i>
Name of witness: GERAINT BREESE	Name of authorised officer: PAUL DAVID
Address of witness: 40 NORTHERN BEACHES COUNCIL 725 PETERWATER RD DEE WHY	Position of authorised officer: SENIOR DEVELOPMENT ENGINEER

(G) **Execution by the registered proprietor**
Certified correct for the purposes of the Real Property Act 1900 and executed on behalf of the company named below by the authorised person(s) whose signature(s) appear(s) below pursuant to the authority specified.

Company: Dee Why Properties No 2 Pty Limited ACN 166 135 422
Authority: Section 127 of the Corporations Act 2001

Signature of authorised person: <i>Nicholas Charles</i>	Signature of authorised person: <i>Justin Johnkucic</i>
Name of authorised person: NICHOLAS CHARLES HAMILTON KENNEDY	Name of authorised person: JUSTIN JOHNKUCIC
Office held: DIRECTOR	Office held: COMPANY SECRETARY

(H) **Consent of the mortgagee**
The mortgagee under mortgage No. AJ994432, agrees to be bound by this positive covenant. I certify that the above mortgagee signed this application in my presence.

Signature of witness: <i>Justin Kucic</i>	Signature of mortgagee: <i>Rachel Tweedy</i>
Name of witness: Justin Kucic	Name of mortgagee: RACHEL TWEEDY Associate Director NAB Corporate Property NSW
Address of witness: 59 ELTHAM ST CLADSVILLE	

* s117 RP Act requires that you must have known the signatory for who holds the position of Level 1 identifying documentation.
ALL HANDWRITING MUST BE IN BLOCK CAPITALS
Page 1 of 3 Under Power of Attorney Registered No 39 Book 4512 in the presence of: 1303

CT 8985

Annexure "A"

Terms of Positive Covenant

The registered proprietors covenant with the Northern Beaches Council (Council) that they will maintain and repair the structure and works on the land in accordance with the following terms and conditions:

VII. The registered proprietor will:

- i. keep the structure and works clean and free from silt, rubbish and debris
- ii. maintain and repair at the sole expense of the registered proprietors the whole of the structure and works so that it functions in a safe and efficient manner.

VIII. For the purpose of ensuring observance of the covenant the Council may by its servants or agents at any reasonable time of the day and upon giving to the person against whom the covenant is enforceable not less than two days notice (but at any time without notice in the case of an emergency) enter the land and view the condition of the land and the state of construction maintenance or repair of the structure and works on the land.

IX. The registered proprietors shall indemnify the Council and any adjoining land owners against any claims for damages arising from the failure of any component of the structure and works, or failure to clean, maintain and repair the structure and works.

X. By written notice the Council may require the registered proprietors to attend to any matter and to carry out such work within such time as the Council may require to ensure the proper and efficient performance of the structure and works and to that extent section 88F(2) (a) of the Act is hereby agreed to be amended accordingly.

XI. Pursuant to section 88F(3) of the Act the authority shall have the following additional powers pursuant to this covenant:

- i. In the event that the registered proprietor fails to comply with the terms of any written notice issued by the Council as set out above the Council or its authorised agents may enter the land with all necessary equipment and carry out any work which the Council in its discretion considers reasonable to comply with the said notice referred to in IV hereof.
- ii. The Council may recover from the registered proprietor in a Court of competent jurisdiction:
 - (a) Any expense reasonably incurred by it in exercising its powers under sub-paragraph i hereof. Such expense shall include reasonable wages for the Council's own employees engaged in effecting the said work, supervising the said work and administering the said work together with costs, reasonably estimated by the Council, for the use of machinery, tools and equipment in conjunction with the said work.

NORTHERN BEACHES COUNCIL

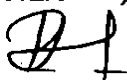
AUTHORISED OFFICER

NICHOLAS CHARLES
HAMILTON KENNEDY

JUSTIN JOHN KUCIC

(b) Legal costs on an indemnity basis for issue of the said notices and recovery of the said costs and expenses together with the costs and expenses of registration of a covenant charge pursuant to section 88F of the Act or providing any certificate required pursuant to section 88G of the Act or obtaining any injunction pursuant to section 88H of the Act.

XII. This covenant shall bind all persons who claim under the registered proprietors as stipulated in section 88E(5) of the Act.

For the purposes of this covenant:

Structure and Works shall mean the Pump-out system constructed on the land as detailed on the plans approved by Council No. {INSERT DA NUMBER}.

The Act means the Conveyancing Act 1919.

NORTHERN BEACHES COUNCIL by its delegate pursuant to S.377 Local Government Act 1993.

.....

Signature of delegate

PAUL DAVID
.....

Name of delegate

I certify that I am an eligible witness and that the delegate signed in my presence

.....

Signature of Witness

GERAINT BREESE
.....

Name of Witness

of NORTHERN BEACHES COUNCIL
725 PITTWATER RD. PEE WHAY
.....

Address of Witness

NICHOLAS CHARLES
HAMILTON KENNEDY

JUSTIN JOHN KUCIC

Form: 13PC
Release: 3-1

POSITIVE COVENANT
New South Wales
Section 88E(3) Conveyancing Act 1919

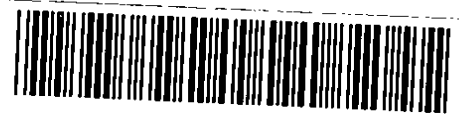

AM709467U

PRIVACY NOTE: Section 31B of the Real Property Act 1900 (RP Act) authorises the Registrar to make available to any person for search upon payment of a fee, if any, the Register made available to any person for search upon payment of a fee, if any.

(A) **TORRENS TITLE** 1/1231319

(B) **LODGED BY**

Document Collection Box <i>W</i>	Name, Address or DX, Telephone, and Customer Account Number if any <i>Andrews & Holm Lawyers PO Box 66 QVB Sydney NSW 1230</i>	CODE PC
Reference: A2M		

(C) **REGISTERED PROPRIETOR**
Of the above land
Dee Why Properties No 2 Pty Limited
ACN 166 135 422

(D) **LESSEE MORTGAGEE or CHARGE**

Of the above land agreeing to be bound by this positive covenant		
Nature of Interest	Number of Instrument	Name
Mortgage	AJ994432	National Australia Bank

(E) **PRESCRIBED AUTHORITY**
Within the meaning of section 88E(1) of the Conveyancing Act 1919
Northern Beaches Council

(F) The prescribed authority having imposed on the above land a positive covenant in the terms set out in annexure A hereto applies to have it recorded in the Register and certifies this application correct for the purposes of the Real Property Act 1900.

DATE *6 September 2017*

(G) **Execution by the prescribed authority**
I certify that an authorised officer of the prescribed authority who is personally known to me or as to whose identity I am otherwise satisfied signed this application in my presence.

Signature of witness: <i>[Signature]</i>	Signature of authorised officer: <i>[Signature]</i>
Name of witness: <i>GERAZINT BREESE</i>	Name of authorised officer: <i>PAUL DAVID</i>
Address of witness: <i>C/O NORTHERN BEACHES COUNCIL 725 PITTWATER RD DEE WHY</i>	Position of authorised officer: <i>SENIOR DEVELOPMENT ENGINEER</i>

(G) **Execution by the registered proprietor**
Certified correct for the purposes of the Real Property Act 1900 and executed on behalf of the company named below by the authorised person(s) whose signature(s) appear(s) below pursuant to the authority specified.

Company: Dee Why Properties No 2 Pty Limited ACN 166 135 422
Authority: Section 127 of the Corporations Act 2001

Signature of authorised person: <i>[Signature]</i>	Signature of authorised person: <i>[Signature]</i>
Name of authorised person: NICHOLAS CHARLES HAMILTON KENNEDY	Name of authorised person: JUSTIN JOHN KUCIC
Office held: DIRECTOR	Office held: COMPANY SECRETARY

(H) **Consent of the mortgagee**
The mortgagee under mortgage No. AJ994432, agrees to be bound by this positive covenant. I certify that the above mortgagee who is personally known to me or as to whose identity I am otherwise satisfied signed this application in my presence.

Signature of witness: <i>[Signature]</i>	Signature of mortgagee: <i>[Signature]</i>
Name of witness: JUSTIN JOHN KUCIC	RACHEL TWEEDY Associate Director NAB Corporate Property NSW
Address of witness: 59 ECTHAM ST. GLADESVILLE NSW	

ANNEXURE "A"

Terms of Positive Covenant

1. The registered proprietor and any user or occupier of the Land Burdened must permit the Prescribed Authority and the Contractor to enter upon the Land Burdened with or without vehicles for
 - a) The purpose of the removal of Waste from such land and to remain upon such land for reasonable time for the purpose of such removal;
 - b) The delivery, removal, inspection and repair of waste containers.
2. The registered proprietor and any user or occupier of the Land Burdened cannot make any claim against the Prescribed Authority or the Contractor for any repairs or damage caused to the Land Burdened as a result of the Prescribed Authority or the Contractor exercising the rights set out in Clause 1. "Repairs and damage caused to the Land Burdened" in this clause 2 shall include repairs of, and damage to, any fixture, flora, kerb, gutter, underground pipe, drain and/or infrastructure located above or beneath the surface of the Land Burdened.
3. The registered proprietor of the Land Burdened must indemnify the Prescribed Authority and the Contractor against any future claim for damage or loss arising from the exercise by the Prescribed Authority or the Contractor of the rights set out in clause 1 except to the extent that such damage or loss is a result of the negligence of the Prescribed Authority or the Contractor as the case may be. "Damage or loss" in this clause 3 shall include damage or loss to the fixture, flora, kerb, guttering, underground pipe, drain and infrastructure located above or beneath the surface of the Land Burdened where such damage or loss is suffered by the said registered proprietor or any other person.
4. The registered proprietor of the Land burdened and any user or occupier of such land must not park any vehicle or place any goods or materials on the Land Burdened which will impede the exercise by the Prescribed Authority or the Contractor in exercising the rights available to them set out in clause 1.
5. Nothing in this Covenant shall oblige the Prescribed Authority or the Contractor to exercise any of the rights set out in Clause 1.
6. The registered proprietor of the Land burdened must use its best endeavours to obtain the consent of any mortgage and/or caveator of the Land Burdened to this covenant and its registration at Land and Property Information New South Wales ("LPI") including obtaining the production of the Certificate of Title of the Land Burdened at LPI to enable registration at such office of this covenant.
7. The Prescribed Authority and the registered proprietor of the Land Burdened will each pay their respective legal costs and out of pocket expenses in relation to the preparation execution and registration of the covenant including the obtaining of any mortgagee's or caveator's consent to such covenant.
8. Northern Beaches Council is the only party authorised to release, vary or modify this instrument.

Authority empowered to release vary or modify the terms of Restriction on the Use of Land or the Positive Covenant.

NORTHERN BEACHES COUNCIL

NICHOLAS CHARLES
HAMILTON KENNEDY

 2 of 3
JUSTIN JOHN KUCIC

NORTHERN BEACHES COUNCIL

Authorised Person

NORTHERN BEACHES COUNCIL by its delegate pursuant to S.377 Local Government Act 1993.



.....
Signature of delegate

PAUL DAVID
.....

Name of delegate

I certify that I am an eligible witness and that the delegate signed in my presence



.....
Signature of Witness

GERAINT BREESE
.....

Name of Witness

C/O NORTHERN BEACHES COUNCIL
725 PITWATER RD DEE WHY
.....

Address of Witness



NICHOLAS CHARLES
HAMILTON KENNEDY



JUSTIN JOHN KUCIC

373

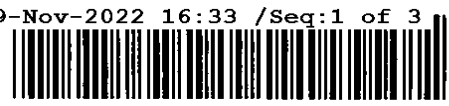

Form: 13PC
 Release: 3-1

POSITIVE COVENANT

New South Wales

Section 88E(3) Conveyancing Act 1919

AM709468S

PRIVACY NOTE: Section 31B of the Real Property Act 1900 (RP Act) authorises the Registrar General to collect the information required by this form for the establishment and maintenance of the Real Property Act Register. Section 96B RP Act requires that the Register is made available to any person for search upon payment of a fee, if any.

(A) TORRENS TITLE	1/1231319		
(B) LODGED BY	Document Collection Box	Name, Address or DX, Telephone, and Customer Account Number if any	CODE
	W	Andrews & Holm Lawyers PO Box 66 QVB Sydney NSW 1230 Reference: A2M	PC
(C) REGISTERED PROPRIETOR	Of the above land Dee Why Properties No 2 Pty Limited ACN 166 135 422		
(D) LESSEE MORTGAGEE or CHARGE	Of the above land agreeing to be bound by this positive covenant		
	Nature of Interest	Number of Instrument	Name
	Mortgage	AJ994432	National Australia Bank
(E) PRESCRIBED AUTHORITY	Within the meaning of section 88E(1) of the Conveyancing Act 1919 Northern Beaches Council		

(F) The prescribed authority having imposed on the above land a positive covenant in the terms set out in annexure A hereto applies to have it recorded in the Register and certifies this application correct for the purposes of the Real Property Act 1900.

DATE **6 September 2017**

(G) Execution by the prescribed authority

I certify that an authorised officer of the prescribed authority who is personally known to me or as to whose identity I am otherwise satisfied signed this application in my presence.

Signature of witness: <i>Geraint Breeze</i>	Signature of authorised officer: <i>Paul David</i>
Name of witness: GERAINT BREESE	Name of authorised officer: PAUL DAVID
Address of witness: 4th FLOOR NORTHERN BEACHES COUNCIL 225 PITTWATER RD DEE WHY	Position of authorised officer: SENIOR DEVELOPMENT ENGINEER

(G) Execution by the registered proprietor

Certified correct for the purposes of the Real Property Act 1900 and executed on behalf of the company named below by the authorised person(s) whose signature(s) appear(s) below pursuant to the authority specified.

Company: Dee Why Properties No 2 Pty Limited ACN 166 135 422	
Authority: Section 127 of the Corporations Act 2001	
Signature of authorised person: <i>Nicholas Charles Hamilton Kennedy</i>	Signature of authorised person: <i>Justin John Kucic</i>
Name of authorised person: NICHOLAS CHARLES HAMILTON KENNEDY	Name of authorised person: JUSTIN JOHN KUCIC
Office held: DIRECTOR	Office held: COMPANY SECRETARY

(H) Consent of the mortgagee

The mortgagee under mortgage No. AJ994432, agrees to be bound by this positive covenant.

I certify that the above mortgagee who is personally known to me or as to whose identity I am otherwise satisfied signed this application in my presence.

Signature of witness: <i>Justin Kucic</i>	Signature of mortgagee: <i>Rachel Tweedy</i>
Name of witness: Justin Kucic	
Address of witness: 59 BETHAM ST CLAYTONVIC NSW	

SIGNED SEALED AND DELIVERED for and on behalf of NATIONAL AUSTRALIA BANK LIMITED ABN-12 004 044 937 by its Attorney who holds the position of **Senior Development Engineer** under Power of Attorney Registered No 39 Book 4512 in the presence of:

Annexure "A"

Terms of Positive Covenant

The registered proprietors covenant with the Northern Beaches Council (Council) that they will maintain and repair the structure and works on the land in accordance with the following terms and conditions:

- I. The registered proprietor will:
 - i. keep the structure and works clean and free from silt, rubbish and debris
 - ii. maintain and repair at the sole expense of the registered proprietors the whole of the structure and works so that it functions in a safe and efficient manner.
- II. For the purpose of ensuring observance of the covenant the Council may by its servants or agents at any reasonable time of the day and upon giving to the person against whom the covenant is enforceable not less than two days notice (but at any time without notice in the case of an emergency) enter the land and view the condition of the land and the state of construction maintenance or repair of the structure and works on the land.
- III. The registered proprietors shall indemnify the Council and any adjoining land owners against any claims for damages arising from the failure of any component of the structure and works, or failure to clean, maintain and repair the structure and works.
- IV. By written notice the Council may require the registered proprietors to attend to any matter and to carry out such work within such time as the Council may require to ensure the proper and efficient performance of the structure and works and to that extent section 88F(2) (a) of the Act is hereby agreed to be amended accordingly.
- V. Pursuant to section 88F(3) of the Act the authority shall have the following additional powers pursuant to this covenant:
 - i. In the event that the registered proprietor fails to comply with the terms of any written notice issued by the Council as set out above the Council or its authorised agents may enter the land with all necessary equipment and carry out any work which the Council in its discretion considers reasonable to comply with the said notice referred to in IV hereof.
 - ii. The Council may recover from the registered proprietor in a Court of competent jurisdiction:
 - (a) Any expense reasonably incurred by it in exercising its powers under sub-paragraph i hereof. Such expense shall include reasonable wages for the Council's own employees engaged in effecting the said work, supervising the said work and administering the said work together with costs, reasonably estimated by the Council, for the use of machinery, tools and equipment in conjunction with the said work.

NORTHERN BEACHES COUNCIL

AUTHORISED OFFICER

Page 2 of 3

NICHOLAS CHARLES
HAMILTON KENNEDY

JUSTIN JOHN KUCIC

(b) Legal costs on an indemnity basis for issue of the said notices and recovery of the said costs and expenses together with the costs and expenses of registration of a covenant charge pursuant to section 88F of the Act or providing any certificate required pursuant to section 88G of the Act or obtaining any injunction pursuant to section 88H of the Act.

VI. This covenant shall bind all persons who claim under the registered proprietors as stipulated in section 88E(5) of the Act.

For the purposes of this covenant:

Structure and Works shall mean the on-site stormwater detention system constructed on the land as detailed on the plans approved by Council No. DA2014/1093 including all gutters, pipes, drains, walls, kerbs, pits, grates, tanks, chambers, basins and surfaces designed to temporarily detain stormwater on the land.

The Act means the Conveyancing Act 1919.

NORTHERN BEACHES COUNCIL by its delegate pursuant to S.377 Local Government Act 1993.

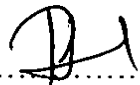

.....

Signature of delegate

PAUL DAVID.....

Name of delegate

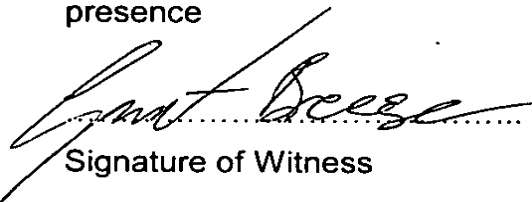
I certify that I am an eligible witness and that the delegate signed in my presence

.....

Signature of Witness

GERAINT BREEZE.....

Name of Witness

40 NORTHERN BEACHES COUNCIL
725 PITTWATER RD DEE WHY

Address of Witness

NICHOLAS CHARLES
HAMILTON KENNEDY

JUSTIN JOHN KUJIC

Form: 15CH
Release: 2.1
Licence: 01-05-086
Licensee: LEAP Legal Software Pty Limited
Firm name: J.S. Mueller & Co

**CONSOLIDATION
CHANGE OF BY-LAWS**
New South Wales
Strata Schemes Management Act 2015
Real Property Act 1900



AP71853Q

PRIVACY NOTE: Section 31B of the Real Property Act 1900 (RP Act) authorises the Registrar General to collect the information required by this form for the establishment and maintenance of the Real Property Act Register. Section 96B RP Act requires that the Register is made available to any person for search upon payment of a fee, if any.

(A) **TORRENS TITLE** For the common property
CP/SP95882

(B) LODGED BY	Document Collection Box	Name, Address or DX, Telephone, and Customer Account Number if any		CODE CH
	47 V	L.L.P.N. 123012 E	H.M. Allen & Co. D.X 437 Sydney Ph 9232 3652	
	Reference:	JSM. 32548		

(C) The Owners-Strata Plan No 95882 certify that a special resolution was passed on 4 October 2018
(D) pursuant to the requirements of section 141 of the Strata Schemes Management Act 2015, by which the by-laws were changed as follows-

(E) Repealed by-law No Not Applicable
Added by-law No Special By-Laws 1, 2 and 3
Amended by-law No Not Applicable

as fully set out below:
See Annexure Hereto

(F) A consolidated list of by-laws affecting the above mentioned strata scheme and incorporating the change referred to at Note (E) is annexed hereto and marked as Annexure "A".

(G) The seal of the Owners-Strata Plan No 95882 was affixed on 12/2/19 in the presence of the following person(s) authorised by section 273 Strata Schemes Management Act 2015 to attest the affixing of the seal:

Signature:

Name: Wade McKenzie

Authority: Strata Manager

Signature: _____

Name:

Authority:





STRATA PLAN NO. 95882

CONSOLIDATION OF BY-LAWS

ANNEXURE "A"

The seal of The Owners - Strata Plan No. 95882 was affixed on 12/2/19 in the presence of the following person(s) authorised by section 273 Strata Schemes Management Act 2015 to attest the affixing of the seal:

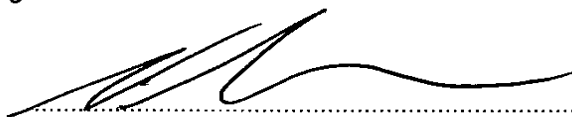
Signature: 

Name(s): Wade McKenney

Authority: Strata Manager



TABLE OF CONTENTS

Developer By-Laws registered with the Strata Plan	5
1 Vehicles	5
2 Changes to common property	6
3 Damage to lawns and plants on common property	7
4 Obstruction of common property	7
5 Keeping of animals	7
6 Noise	8
7 Behaviour of owners, occupiers and invitees	8
8 Children playing on common property	9
9 Smoke penetration	9
10 Preservation of fire safety	10
11 Storage of inflammable liquids and other substances and materials.....	10
12 Appearance of lot	10
13 Cleaning windows and doors	11
14 Hanging out of washing	11
15 Disposal of waste – shared bins	11
16 Garbage disposal	12
17 Change in use or occupation of lot to be notified	14
18 Compliance with planning and other requirements	15
19 Balcony and terrace lots – awning installation	15
20 Maintenance of garden beds	16
21 Right of developer to locate and/or relocate air-conditioning plant.....	16
22 Moving certain articles	17
23 Curtains	18
24 Air-conditioning equipment	18
25 Storage.....	19
26 Floor coverings	20

Dictionary.....	21
ADDITIONAL BY-LAWS.....	22
Special By-Law No. 1 – Over Car Bonnet Storage Units (Added)	22
Special By-Law No. 2 – Rules for Short Term Accommodation (Added).....	27
Special By-Law No. 3 – Real Estate Signs (Added).....	31
Execution Page.....	32
Approved Form 10.....	33

1 Vehicles

1.1 An owner or occupier of a lot must not park or stand any motor or other vehicle on common property, or permit a motor vehicle to be parked or stood on common property, except with the prior written approval of the owners corporation or as permitted by a sign authorized by the owners corporation.

1.2 In addition to the powers, authorities, duties and functions conferred by or imposed on it by the Act, the owners corporation shall have the additional powers, authorities, duties and functions in relation to car parking subject to the conditions of this by-law as follows:

- (a)** the power to regulate the use of the common property and the visitor car parking space for parking of motor or other vehicles;
- (b)** the power to wheel clamp motor or other vehicles parked or left in contravention of this by-law, at the expense of the owner or occupier of the motor or other vehicle clamped;
- (c)** the power to enter into arrangements with third parties (including vehicle towing services) to remove or wheel clamp motor or other vehicles that are parked or left in contravention of this by-law, at the expense of the owner or occupier of the motor or other vehicle removed or clamped; and
- (d)** the power to erect signage regarding parking including, advising that motor or other vehicles parked or left in contravention of this by-law will be removed from the parcel or wheel clamped, at the expense of the owner or occupier of the motor or other vehicle removed or clamped.

2 Changes to common property

2.1 An owner or person authorized by an owner may install, without the consent of the owners corporation:

- (a) any locking or other safety device for protection of the owner's lot against intruders or to improve safety within the owner's lot, or**
- (b) any screen or other device to prevent entry of animals or insects on the owner's lot, or**
- (c) any structure or device to prevent harm to children.**

2.2 Any such locking or safety device, screen, other device or structure must be installed in a competent and proper manner and must have an appearance, after it has been installed, in keeping with the appearance of the rest of the building.

2.3 Clause 2.1 does not apply to the installation of anything that is likely to affect the operation of fire safety devices in the lot or to reduce the level of safety in the lots or common property.

2.4 The owner of a lot must:

- (a) maintain and keep in a state of good and serviceable repair any installation or structure referred to in clause 2.1 that forms part of the common property and that services the lot, and**
- (b) repair any damage caused to any part of the common property by the installation or removal of any locking or safety device, screen, other device or structure referred to in clause 2.1 that forms part of the common property and that services the lot.**

3 Damage to lawns and plants on common property

3.1 Subject to by-law 20, an owner or occupier of a lot must not, except with the prior written approval of the owners corporation:

- (a) damage any lawn, garden, tree, shrub, plant or flower being part of or situated on common property, or
- (b) use for his or her own purposes as a garden any portion of the common property.

4 Obstruction of common property

4.1 An owner or occupier of a lot must not obstruct lawful use of common property by any person except on a temporary and non-recurring basis.

5 Keeping of animals

5.1 An owner or occupier of a lot must not, except with the prior written approval of the owners corporation, keep any animal (except up to two small dogs (not to exceed 14kg each in weight) or one cat or small caged bird or fish kept in a secure aquarium) on the lot or the common property.

5.2 The owners corporation must not unreasonably withhold its approval of the keeping of an animal on the lot or the common property, when such approval is sought pursuant to by-law 5.1.

5.3 If an owner or occupier of a lot keeps any animal on a lot permitted under this by law 5, then the owner or occupier must:

- (a) notify the owners corporation that the animal is kept on the lot; and
- (b) keep the animal within the lot; and
- (c) carry the animal when it is on the common property or keep it on a lead; and

- (d) take such action necessary to clean all areas of the lot or the common property that are soiled or damaged by the animal.
- (e) despite any other provision of this by-law 5, on no account is an owner or occupier of a lot permitted to keep any unregistered dog or any dog which is:
 - (i) a pit bull terrier, Japanese tosa, dogo Argentino, fila Brasileiro or other outcross; or
 - (ii) prohibited from importation into Australia; or
 - (iii) declared to be dangerous or a restricted dog under the *Companion Animals Act 1998*, as amended, from time to time.

5.4 An owner or occupier of a lot who keeps an assistance animal on the lot must, if required to do so by the owners corporation, provide evidence to the owners corporation demonstrating that the animal is an assistance animal as referred to in section 9 of the *Disability Discrimination Act 1992* of the Commonwealth.

6 Noise

6.1 An owner or occupier of a lot, or any invitee of an owner or occupier of a lot, must not create any noise on a lot or the common property likely to interfere with the peaceful enjoyment of the owner or occupier of another lot or of any person lawfully using common property.

7 Behaviour of owners, occupiers and invitees

7.1 An owner or occupier of a lot, or any invitee of an owner or occupier of a lot, when on common property must be adequately clothed and must not use language or behave in a manner likely to cause offence or embarrassment to

the owner or occupier of another lot or to any person lawfully using common property.

7.2 An owner or occupier of a lot must take all reasonable steps to ensure that invitees of the owner or occupier:

(a) do not behave in a manner likely to interfere with the peaceful enjoyment of the owner or occupier of another lot or any person lawfully using common property, and

(b) without limiting paragraph 7.2(a), that invitees comply with clause 7.1.

8 Children playing on common property

8.1 Any child for whom an owner or occupier of a lot is responsible may play on any area of the common property that is designated by the owners corporation for that purpose but only while under adult supervision.

8.2 An owner or occupier of a lot must not permit any child for whom the owner or occupier is responsible, unless accompanied by an adult exercising effective control, to be or remain on common property that is a laundry, car parking area or other area of possible danger or hazard to children.

9 Smoke penetration

9.1 An owner or occupier, and any invitee of the owner or occupier, must not smoke tobacco or any other substance on the common property.

9.2 An owner or occupier of a lot must ensure that smoke caused by the smoking of tobacco or any other substance by the owner or occupier, or any invitee of the owner or occupier, on the lot does not penetrate to the common property or any other lot.

10 Preservation of fire safety

10.1 The owner or occupier of a lot must not do anything or permit any invitees of the owner or occupier to do anything on the lot or common property that is likely to affect the operation of fire safety devices in the parcel or to reduce the level of fire safety in the lots or common property.

11 Storage of inflammable liquids and other substances and materials

11.1 An owner or occupier of a lot must not, except with the prior written approval of the owners corporation, use or store on the lot or on the common property any inflammable chemical, liquid or gas or other inflammable material.

11.2 This by-law does not apply to chemicals, liquids, gases or other material used or intended to be used for domestic purposes, or any chemical, liquid, gas or other material in a fuel tank of a motor vehicle or internal combustion engine.

12 Appearance of lot

12.1 The owner or occupier of a lot must not, without the prior written approval of the owners corporation, maintain within the lot anything visible from outside the lot that, viewed from outside the lot, is not in keeping with the rest of the building.

12.2 This by-law does not apply to the hanging of any clothing, towel, bedding or other article of a similar type in accordance with by-law 14 or to the installation of an awning in accordance with by-law 19.

13 Cleaning windows and doors

- 13.1 Except in the circumstances referred to in clause 13.2, an owner or occupier of a lot is responsible for cleaning all interior and exterior surfaces of glass in windows and doors on the boundary of the lot, including so much as is common property.
- 13.2 The owners corporation is responsible for cleaning regularly all exterior surfaces of glass in windows and doors that cannot be accessed by the owner or occupier of the lot safely or at all.

14 Hanging out of washing

- 14.1 An owner or occupier of a lot may hang washing on any part of the lot other than over the balcony railings. The washing may only be hung for a reasonable period.
- 14.3 In this by-law:
washing includes any clothing, towel, bedding or other article of a similar type.

15 Disposal of waste—shared bins

- 15.1 An owner or occupier of a lot must not deposit or throw on the common property any rubbish, dirt, dust or other material or discarded item except with the prior written approval of the owners corporation.
- 15.2 An owner or occupier of a lot must not deposit in a toilet, or otherwise introduce or attempt to introduce into the plumbing system, any item that is not appropriate for any such disposal (for example, a disposable nappy).
- 15.3 An owner or occupier must:

- (a) comply with all reasonable directions given by the owners corporation as to the disposal and storage of waste (including the cleaning up of spilled waste) on common property, and
 - (b) comply with the local council's guidelines for the storage, handling, collection and disposal of waste.
- 15.4 The owners corporation may give directions for the purposes of this by-law by posting signs on the common property with instructions on the handling of waste that are consistent with the local council's requirements or giving notices in writing to owners or occupiers of lots.
- 15.5 In this by-law:
- bin* includes any receptacle for waste.
 - waste* includes garbage and recyclable material.

16 Garbage disposal

- 16.1 An owner or occupier of a lot in a strata scheme that does not have shared receptacles for garbage, recyclable material or waste:
- (a) must maintain such receptacles within the lot, or on such part of the common property as may be authorised by the owners corporation, in a clean and dry condition and (except in the case of receptacles for recyclable materials) adequately covered; and
 - (b) must ensure that before garbage, recyclable material or waste is placed in the receptacles it is, in the case of garbage, securely wrapped or, in the case of tins or other containers, completely drained or, in the case of recyclable material or waste, separated and prepared in accordance with the applicable recycling guidelines; and
 - (c) for the purpose of having the garbage, recyclable material or waste collected, must place the receptacles within an area designated for

that purpose by the owners corporation and at a time not more than 12 hours before the time at which garbage, recyclable material or waste is normally collected; and

- (d) when the garbage, recyclable material or waste has been collected, must promptly return the receptacles to the lot or other area referred to in by-laws 16.1(a) and 16.1(c); and
- (e) must not place anything in the receptacles of the owner or occupier of any other lot except with the permission of that owner or occupier; and
- (f) must promptly remove any thing which the owner, occupier or garbage or recycling collector may have spilled from the receptacles and must take such action as may be necessary to clean the area within which that thing was spilled.

16.2 An owner or occupier of a lot in a strata scheme that has shared receptacles for garbage, recyclable material or waste:

- (a) must ensure that before garbage, recyclable material or waste is placed in the receptacles it is, in the case of garbage, securely wrapped or, in the case of tins or other containers, completely drained or, in the case of recyclable material or waste, separated and prepared in accordance with the applicable recycling guidelines; and
- (b) must promptly remove any thing, which the owner, occupier or garbage or recycling collector may have spilled in the area of the receptacles and must take such action as may be necessary to clean the area within which that thing was spilled.

- 16.3 An owner or occupier of a lot must:**
- (a) comply with the local council's requirements for the storage, handling and collection of garbage, waste any recyclable material; and
 - (b) notify the local council of any loss of, or damage to, receptacles provided by the local council for garbage, recyclable material or waste.
- 16.4 The owners corporation may post signs on the common property with instructions on the handling of garbage, waste and recyclable material that are consistent with the local council's requirements.**
- 16.5 The owners corporation must ensure that waste and recycling containers and bulk waste materials, as required by Northern Beaches Council ("Council") are presented in the access way to the west of the Building for collection. The owners corporation must ensure that the access way for collection of waste is not obstructed in any way by vehicles or any structures which may inhibit the collection of waste. The Council may, in its absolute discretion, terminate the collection and removal of waste from the Building and direct that collection and removal of waste be from the kerbside of the nearest public road.**
- 17 Change in use or occupation of lot to be notified**
- 17.1 An occupier of a lot must notify the owners corporation if the occupier changes the existing use of the lot.**
- 17.2 Without limiting clause 17.1, the following changes of use must be notified:**
- (a) a change that may affect the insurance premiums for the strata scheme (for example, if the change of use results in a hazardous activity being carried out on the lot, or results in the lot being used for commercial or industrial purposes rather than residential purposes),

(b) a change to the use of a lot for short-term or holiday letting.

17.3 The notice must be given in writing at least 21 days before the change occurs or a lease or sublease commences.

18 Compliance with planning and other requirements

18.1 The owner or occupier of a lot must ensure that the lot is not used for any purpose that is prohibited by law.

18.2 The owner or occupier of a lot must ensure that the lot is not occupied by more persons than are allowed by law to occupy the lot.

19 Balcony and courtyard lots – installation of awnings

19.1 The owners or occupiers of lots 1, 2, 3, 4, 5, 6, 7, 8, 9, 10, 11, 12, 13, 14, 15, 67, 68, 69, 70, 73, 74, 75, 76, 77, 78, 80, 81, 82, 83, 84, 85, 86, 87, 88, 96, 97 and 103 (“Balcony and Terrace Lots”) in the Strata Scheme may install an awning over their respective balconies and terraces, subject to the owners or occupiers of the Balcony and Terrace Lots fulfilling the following prerequisites before the installation of the awning the owner or occupier of a Balcony and Terrace Lot must:

- (a) obtain, at that owner’s or occupier’s sole cost and expense, all necessary consents from the local council and from any other relevant and competent authority required for such installation, and provide a copy of the consent to the owners corporation; and
- (b) at that owner’s or occupier’s sole cost and expense, provide a structural engineers certificate confirming that the awning is structurally adequate and sound; and
- (c) comply with the reasonable requirements of the owners corporation in relation to the installation of the awning;

- (d) submit awning specifications, including colour and size to the owners corporation for approval of the owners corporation, subject approval must not be unreasonably withheld.
- 19.2 The owners and occupiers of the Balcony and Terrace Lots are solely responsible for the installation, ongoing costs, and repair and maintenance of the awning relating to their respective lot.
- 19.3 The owner or occupier of a Balcony and Terrace Lot must indemnify the owners corporation from and against any loss or damage that may be suffered as a result of an owner or occupier's rights pursuant to this by-law 19.

- 20 Maintenance of garden beds**
- 20.1 The owners or occupiers of lots 8 and 9 must, at their own cost and expense, maintain the garden beds located within their respective lots, to a standard reasonably required by the owners corporation.

- 21 Right of developer to undertake works/locate and/or relocate Air-conditioning Plant**
- 21.1 The Developer may, at the Developer's sole cost and expense undertake works to any part of the common property or Plant, and locate and/or relocate any Plant currently installed in or on the common property of the Building to any other common property of the Building without the owners corporation approval or consent, provided all damage is made good by the Developer. Should any works or relocation require owners corporation consent to be provided to any authority, such consent must not be unreasonably withheld by the owners corporation.

22 Moving of certain articles

22.1 An owner or occupier of a lot must not transport any goods, equipment, furniture or other large objects to and from lots and through common property ("Removals") unless:

- (a)** A booking has been made and confirmed with the owners corporation in writing within a reasonable time (at least 24 hrs) before Removals are carried out: -
 - (i)** to book the lift;
 - (ii)** to ensure that lift covers are in place;
 - (iii)** to give notice of any necessary security arrangements; and
 - (iv)** to notify any representative of the owners corporation (if considered necessary).
- (b)** Removals may only be carried out on Mondays to Saturdays between the hours of 9.00am and 4.00pm or in accordance with the permitted hours determined by the owners corporation from time to time;
- (c)** Removals are not carried out on Sundays;
- (d)** All areas are protected from damage when carrying out Removals and all rubbish is removed from the strata scheme and its surrounds; and
- (e)** All Removals are transported in the manner reasonably directed by the owners corporation;
- (f)** The owner agrees to repair any damage caused to common property (whether caused by the owner or the person moving the goods); and
- (g)** Anything spilt onto the common property (by the owner or the person moving the goods) is immediately removed and that part of the common property cleaned.

22.2 If required by the owners corporation, an owner of a lot must pay to the owners corporation an amount of \$500.00 (or any other amount the owners corporation may decide from time to time) which is:

- (a) to be held by the owners corporation as a bond during the Removal or delivery of goods and furniture through the common property areas and lifts;
- (b) to be applied by the owners corporation towards the cost of rectifying any damage to any part of the common property including the foyers and lifts and the cost of providing any necessary security arrangements; and
- (c) to be refunded to the owner in whole, if any part is applied pursuant to this by-law, then only as to the balance.

23 Curtains

23.1 Any curtain or blind in a window or door, which faces public or common areas, must have a backing coloured beige, off-white or cream unless otherwise authorised in writing by the owners corporation, must not be a vertical blind, must not detract from the visible amenity of the Building, and must be in keeping with the rest of the Building.

24 Air Conditioning Equipment

24.1 The owners for the time being of each lot shall be entitled to the exclusive use of the Air Conditioning Equipment subject to the conditions that:

- (a) each owner shall be responsible for the running costs, the proper maintenance and keeping in a state of good and serviceable repair, the renewal and replacement of the Air Conditioning Equipment; and

- (b) each owner must maintain the Air Conditioning Equipment to a standard and if renewed or replaced of a type and colour, as may be prescribed by the owners corporation from time to time.

25 Storage

- 25.1 An owner or occupier of a lot may only use their storage space for any lawful use.
- 25.2 An owner or occupier of a lot must:
 - (a) keep their storage space clean and tidy at all times;
 - (b) maintain and repair their storage space;
 - (c) jointly with the owner of an adjoining space, maintain and repair the dividing wire mesh (if any) separating their respective storage spaces; and
 - (d) give the owners corporation access to their storage space, if the owners corporation needs to comply with its obligations under the by-laws or the Management Act.
- 25.3 An owner or occupier of a lot must not:
 - (a) use their storage space for any unlawful use;
 - (b) keep flammable materials in their storage space; or
 - (c) deposit or leave garbage or recyclable materials in their storage space; or
 - (d) impede or interfere with any firefighting device, for example a sprinkler head.

26 Floor coverings

- 26.1** An owner of a lot must ensure that all floor space within the lot is covered or otherwise treated to an extent sufficient to prevent the transmission from the floor space of noise likely to disturb the peaceful enjoyment of the owner or occupier of another lot.
- 26.2** By-law 26.1 does not apply to floor space comprising a kitchen, laundry, lavatory or bathroom.

DICTIONARY

Air Conditioning Equipment means the air conditioning equipment for each lot in the ceiling space and ducting of the common property servicing and adjacent to that lot.

Plant means any plant or equipment servicing the Building or any lot in the strata scheme, including but not limited to lifts, fire services, air conditioning plant, condenser units, pipes, wires, cables, vents and ducts.

Building means the building and improvements on the land situated at 23 Pacific Parade, Dee Why, NSW 2099 and comprising a strata titled residential apartment building.

Management Act means the *Strata Schemes Management Act 2015*, as amended.

Developer means **Dee Why Properties No 2 Pty Limited ACN 166 135 422**, being the registered proprietor of the land comprised in the Strata Scheme before registration of the strata plan creating same.

owners corporation means the owners corporation formed on registration of the strata scheme for the Building.

Parcel means the land comprised in the strata plan.

strata scheme means the strata scheme created on registration of the strata plan accompanying these by-laws.

ADDITIONAL BY-LAWS

Special By-Law No. 1 – Over Car Bonnet Storage Units (Added)

1. Introduction

- (a) This by-law sets out the rules you must follow if you want to install and keep a storage unit in your car space.
- (b) You must comply with this by-law.
- (c) If you do not comply with this by-law the owners corporation may take action against you. This may result in your storage unit being removed or a monetary penalty being imposed on you.

2. Definitions

In this by-law:

“**car space**” means a car space that is a lot or forms part of a lot;

“**storage unit**” means a Space Commander Over Car Bonnet Storage Unit of a type shown in the specification sheet that is located in your car space;

“**lot**” means a lot in Strata Plan No. 95882;

“**specification sheet**” means the Space Commander storage unit models and sizes document that is attached to this by-law; and

“**you**” means the owner for the time being of a lot (being the current owner and all successors).

3. Authority to Install Storage units

- (a) You may install and retain a storage unit in your car space provided that you comply with the conditions of this by-law.
- (b) You must not install any type of storage unit in your car space apart from a Space Commander Over Car Bonnet Storage Unit of a type shown in the specification sheet that is grey in colour.

4. General Conditions

(a) Prior Notice

At least fourteen (14) days before installing a storage unit, you must give the strata committee a written notice containing information about the storage unit including the make, model and proposed location of the storage unit and your written consent to this by-law.

(b) Planning Approvals

Before installing a storage unit, you must, if required by law, obtain development consent or a complying development certificate for the storage unit from the Local Council or a private certifier, and give the owners corporation a complete copy of the consent or certificate.

(c) Insurance Certificates

Before installing a storage unit, you must give the owners corporation a copy of the certificate of currency for the public liability insurance policy of the contractor who will install the storage unit.

(d) Strata Committee Directions

You must comply with any reasonable directions the strata committee issues concerning the installation and keeping of the storage unit including the location of the storage unit.

(e) Quality of Workmanship

The storage unit must be installed in a proper and workmanlike manner by appropriately licensed and qualified tradespersons utilising only first quality materials which are good and suitable for the purpose for which they are used.

(f) Building Code of Australia and Australian Standards

The storage unit must be installed in accordance with and comply with the Building Code of Australia and any applicable Australian Standard.

(g) Period for Installation

The storage unit must be installed with due diligence and the installation must be completed within a reasonable period from the date of commencement.

(h) Disturbance

Only minimum disturbance may be caused to the common property and the owners and occupiers of the other lots during the installation of the storage unit.

(i) Transportation of Construction Equipment

All construction materials and equipment must be transported in accordance with any manner reasonably directed by the executive committee.

(j) Storage of Building Materials on Common Areas

You must make sure that no building materials are stored on the common property during work on the storage unit.

(k) Protection of Building

You must protect the common property, your car space and any goods in your car space (including any motor vehicle) that is affected by work on the storage unit from damage.

(l) Maintenance & Repairs of Storage Unit

You must properly maintain and keep in a state of good and serviceable repair your storage unit and, when necessary, renew or replace the whole or any part of the storage unit.

(m) Maintenance & Repairs of Common Property

You must properly maintain and keep in a state of good and serviceable repair any common property occupied by your storage unit and, when necessary, renew or replace any fixtures or fittings comprised in the common property occupied by your storage unit.

(n) Repair of Damage

You must make good any damage to the common property caused as a result of the installation or use of the storage unit.

(o) Interference with Car Space

You must ensure that the storage unit does not hinder or obstruct the parking of a motor vehicle in your car space or the use of another car space or any common property.

(p) Noise and Disturbance

You must ensure that the use of the storage unit does not disturb the peaceful enjoyment of the owner or occupier of another lot or any person on common property.

(q) Appearance

You must ensure that the storage unit has an appearance that is in keeping with the appearance of the rest of the building when viewed from outside your car space and that the storage unit is grey in colour.

(r) Safety

You must ensure that any items to be kept in the storage unit are securely stored inside the storage unit (and not on top of the storage unit) and that the storage unit does not create or pose a risk to the health or safety of any person in or about your car space.

(s) Indemnity

You must indemnify and keep indemnified the owners corporation against all actions, proceedings, claims, demands, costs, damages and expenses which may be incurred by or brought or made against the owners corporation arising out of the storage unit or the altered state or use of your car space arising from the storage unit.

(t) Compliance with all Laws

You must comply with all statutes, by-laws, regulations, rules and other laws for the time being in force and which are applicable to the storage unit.

(u) Breach of this By-Law

If you breach any condition of this by-law and fail to rectify that breach within thirty (30) days of service of a written notice from the owners corporation requiring rectification of that breach, then the owners corporation may:-

- (i) rectify the breach,
- (ii) enter on any part of the building, by its agents, employees or contractors, in accordance with the Strata Schemes Management Act 2015, for the purpose of rectifying the breach, and

- (iii) recover as a debt due from you the costs of the rectification and the expenses of the owners corporation incurred in recovering those costs.

Nothing in this clause restricts the rights of or the remedies available to the owners corporation as a consequence of a breach of this by-law.



Specification Sheet



Over Car Bonnet Range

SC2511	SC2518	SC2581	SC2588
Largest height, largest depth	Reduce height, largest depth	Largest height, reduced depth	Reduce height, reduced depth
Width: 2510mm or 2400mm Depth: 1110mm Height: 2320mm	Width: 2510mm or 2400mm Depth: 1110mm Height: 2020mm	Width: 2510mm or 2400mm Depth: 810mm Height: 2320mm	Width: 2510mm or 2400mm Depth: 810mm Height: 2020mm
3.2 m ³ capacity	2.5 m ³ capacity	2.4 m ³ capacity	1.8 m ³ capacity

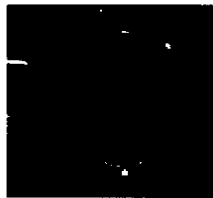
Double Decker Range

SC2511DD	SC2518DD	SC2581DD	SC2588DD
			
Largest height, largest depth	Reduce height, largest depth	Largest height, reduced depth	Reduce height, reduced depth
Width: 2510mm or 2400mm Depth: 1110mm Height: 2320mm	Width: 2510mm or 2400mm Depth: 1110mm Height: 2020mm	Width: 2510mm or 2400mm Depth: 810mm Height: 2320mm	Width: 2510mm or 2400mm Depth: 810mm Height: 2020mm
5.6 m ³ capacity	5.0 m ³ capacity	4.2 m ³ capacity	3.6 m ³ capacity

Other Info...

- Models & Sizes

- Accessories

- How to Buy

- Gallery

- Warranty

Other Products



Special By-Law No. 2 – Rules for Short Term Accommodation (Added)

1. Introduction

This by-law sets out rules you must follow if you use your apartment, or allow your apartment to be used, for short term accommodation.

2. Definitions and Interpretation

2.1 In this by-law, unless the context or subject matter otherwise indicates or requires:

- (a) “**Act**” means the *Strata Schemes Management Act 2015*,
- (b) “**adults**” means any persons 18 years of age or older but does not include excluded adults,
- (c) “**apartment**” means any residential lot in the strata scheme,
- (d) “**bedroom**” means a room approved for use as a bedroom under, or indicated as a bedroom in any plans the subject of, a planning approval for the strata scheme,
- (e) “**building**” means any building in the strata scheme,
- (f) “**common property**” means the common property in the strata scheme,
- (g) “**Council**” means the Northern Beaches Council and any successor,
- (h) “**excluded adults**” means (where all of the adults who reside in an apartment are related to each other) any adults who are related to each other,
- (i) “**guest list**” means a list of any guests who from time to time who use an apartment for short term accommodation and which includes the names, addresses and mobile telephone numbers of those guests and the dates between which those guests use the apartment for short term accommodation,
- (j) “**guests**” means any persons who use an apartment for short term accommodation,
- (k) “**insurance**” means a policy of insurance in respect of damage to property, death or bodily injury for which you could become liable in damages arising out of the use of your apartment for short term accommodation for a cover of not less than \$10,000,000 for each event in respect of which any claim or claims may be made,
- (l) “**lot**” means any lot in the strata scheme,
- (m) “**Planning Act**” means the *Environmental Planning and Assessment Act 1979* including any amendment of it and any legislation replacing it,
- (n) “**planning approvals**” means any approvals or consents of the Council or any other entity issued under the Planning Act to authorise or permit an apartment to be used for short term accommodation,
- (o) “**Regulation**” means the *Strata Schemes Management Regulation 2016*,
- (p) “**related to each other**” means related to each other within the meaning of clause 36 of the Regulation,

- (q) “**security key**” means any key or device that operates to provide access to an apartment or the building,
- (r) “**short term accommodation**” means occupation of an apartment by one or more persons temporarily, or for a period of less than three months, on a commercial basis,
- (s) “**strata scheme**” means the strata scheme to which this by-law applies,
- (t) “**you**” means an owner or occupier of an apartment (but does not include guests).

2.2 In this by-law, unless the context or subject matter otherwise indicates or requires:

- (a) headings have been inserted for guidance only and do not affect the interpretation of this by-law,
- (b) references to any legislation include any legislation amending, consolidating or replacing the same, and all by-laws, ordinances, proclamations, regulations, rules and other authorities made under them,
- (c) words importing the singular number include the plural and vice versa,
- (d) where any word or phrase is given a definite meaning any part of speech or other grammatical form in respect of that word or phrase has a corresponding meaning,
- (e) any expression used in this by-law and which is defined in the Act will have the same meaning as that expression has in that Act unless a contrary intention is expressed in this by-law, and
- (f) if there is any inconsistency between this by-law and any other by-law applicable to the strata scheme, then the provisions of this by-law will prevail to the extent of that inconsistency.

3. Planning Approvals

- 3.1 Before using your apartment, or allowing your apartment to be used, for short term accommodation, you must obtain, or ensure there exists, all necessary planning approvals to permit your apartment to be used for short term accommodation.
- 3.2 If you use your apartment, or allow your apartment to be used, for short term accommodation, you must give the owners corporation a copy of all necessary planning approvals to permit your apartment to be used for short term accommodation when requested to do so by the owners corporation.

4. Insurance

- 4.1 Before using your apartment, or allowing your apartment to be used, for short term accommodation, you must obtain insurance.
- 4.2 If you use your apartment, or allow your apartment to be used, for short term accommodation, you must ensure that insurance is in place.
- 4.3 You must give the owners corporation a copy of a certificate of currency for your insurance when requested to do so by the owners corporation.

5. Guest List

- 5.1 If you use your apartment, or allow your apartment to be used, for short term accommodation, you must:

- (a) keep a guest list for your apartment,
- (b) ensure that the guest list for your apartment is kept up-to-date.

5.2 You must give the owners corporation a copy of the guest list for your apartment when requested to do so by the owners corporation.

6. Rules for Short Term Accommodation

6.1 You must take all reasonable steps to ensure that any guests who use your apartment for short term accommodation:

- (a) **(nuisance)** do not cause a nuisance to, or disturb the peaceful enjoyment of, the owner or occupier of another apartment or any person on common property;
- (b) **(noise)** do not create any noise in your apartment or on the common property likely to interfere with the peaceful enjoyment of the owner or occupier of another apartment or of any person on common property,
- (c) **(smoking)** do not smoke in your apartment or on the common property if smoking is prohibited in either area under the by-laws applicable to the strata scheme and, if smoking is permitted in your apartment, that smoke caused by the smoking of guests in your apartment does not penetrate to the common property or any other apartment,
- (d) **(fire safety)** do not do anything in your apartment or on the common property that is likely to affect the operation of fire safety devices in the strata scheme or reduce the level of fire safety in the apartments or common property,
- (e) **(security)** do not do anything to compromise or prejudice the security of the strata scheme,
- (f) **(damage)** do not damage or cause any damage to the common property,
- (g) **(services)** do not use any equipment or services in the strata scheme for any purpose other than the purpose for which they are designed or intended to be used,
- (h) **(garbage)** dispose of garbage, waste and recyclable materials in accordance with the by-laws and any reasonable directions of the owners corporation.

6.2 If you are a guest, you must not do or omit to do any of the things identified in clause 6.1.

7. Security Keys

7.1 You must not keep or store any security key for your apartment or the building on the common property including in any lock box.

7.2 The owners corporation may move or remove any security key that is kept or stored on the common property or any lock box in which a security key is kept or stored on the common property.

7.3 You must take all reasonable steps to ensure that your guests do not:

- (a) copy or duplicate,
- (b) share,
- (c) lose, or

(d) damage or destroy,

any security key for your apartment or the building.

7.4 You must notify the owners corporation immediately you become aware that any security key for your apartment or the building is copied, duplicated, shared, lost, damaged or destroyed.

8. Occupancy Limits

8.1 If you use your apartment, or allow your apartment to be used, for short term accommodation, you must ensure that your apartment is not occupied by more than two adults per bedroom in your apartment.

8.2 You must take all reasonable steps to ensure that your guests comply with clause 8.1 of this by-law.

8.3 This clause is subject to section 137(3) of the Act.

9. Indemnity

You must indemnify and keep indemnified the owners corporation against all actions, proceedings, claims, demands, costs, damages and expenses which may be incurred by or brought or made against the owners corporation arising out of the use of your apartment for short term accommodation or any breach of this by-law by you.

10. Rules for Guests

10.1 You must provide your guests with a copy of the by-laws that are applicable to the strata scheme including this by-law before or as soon as reasonably practicable after your guests commence using your apartment for short term accommodation.

10.2 If you are a guest, you must comply with the by-laws that are applicable to the strata scheme to the extent that the by-laws are applicable to you.

Special By-Law No. 3 – Real Estate Signs (Added)

- (1) An owner or occupier of a lot must not install, place or keep:-
 - (a) on any part of the common property; or
 - (b) on any part of the lot so as to be visible from outside the lot;

any real estate sign including a “for sale” sign or a “for lease” sign.

- (2) An owner or occupier of a lot must not permit any person to install, place or keep:-
 - (a) on any part of the common property; or
 - (b) on any part of the lot so as to be visible from outside the lot;

any real estate sign including a “for sale” sign or a “for lease” sign.

- (3) An owner or occupier of a lot must not damage, or permit any other person to damage, any part of the common property by installing, placing or keeping any real estate sign including a “for sale” sign or a “for lease” sign on the common property.

- (4) If an owner or occupier of a lot breaches this by-law the owners corporation may:-
 - (a) remedy the breach;

 - (b) recover from the owner or occupier as a debt:-
 - (i) the costs incurred by the owners corporation remedying the breach; and
 - (ii) the costs and expenses of the owners corporation incurred recovering those costs including legal costs on an indemnity basis.

Execution Page

The seal of The Owners - Strata Plan No. 95882 was affixed on 12/2/19. in the presence of the following person(s) authorised by section 273 Strata Schemes Management Act 2015 to attest the affixing of the seal:

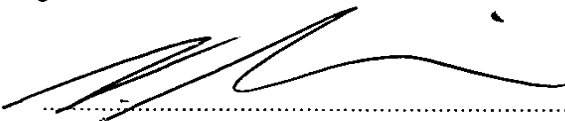
Signature: 

Name(s): Wade McKensie

Authority: Strata Manager

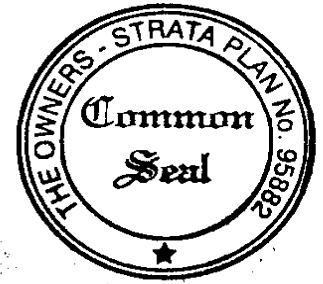

Approved Form 10

Created 2016

Certificate re Initial Period

The owners corporation certifies that in respect of the strata scheme:

*that the initial period has expired.

~~*the original proprietor owns all of the lots in the strata scheme and any purchaser under an exchanged contract for the purchase of a lot in the scheme has consented to any plan or dealing being lodged with this certificate.~~

The seal of The Owners - Strata Plan No. 95882 was affixed on 12/2/19 in the presence of the following person(s) authorised by section 273 *Strata Schemes Management Act 2015* to attest the affixing of the seal.

Signature: [Handwritten Signature] Name: Wade McLeish Authority: Strata Manager

Signature: Name: Authority:



Asset Information

Legend

Sewer		Property Details	
Sewer Main (with flow arrow & size type text)		Boundary Line	
Disused Main		Easement Line	
Rising Main		House Number	
Maintenance Hole (with upstream depth to invert)		Lot Number	
Sub-surface chamber		Proposed Land	
Maintenance Hole with Overflow chamber		Sydney Water Heritage Site (please call 132 092 and ask for the Heritage Unit)	
Ventshaft EDUCT			
Ventshaft INDUCT			
Property Connection Point (with chainage to downstream MH)			
Concrete Encased Section			
Terminal Maintenance Shaft			
Maintenance Shaft			
Rodding Point			
Lamphole			
Vertical			
Pumping Station			
Sewer Rehabilitation			
Pressure Sewer		Water	
Pressure Sewer Main		WaterMain - Potable (with size type text)	
Pump Unit (Alarm, Electrical Cable, Pump Unit)		Disconnected Main - Potable	
Property Valve Boundary Assembly		Proposed Main - Potable	
Stop Valve		Water Main - Recycled	
Reducer / Taper		Special Supply Conditions - Potable	
Flushing Point		Special Supply Conditions - Recycled	
		Restrained Joints - Potable	
		Restrained Joints - Recycled	
		Hydrant	
		Maintenance Hole	
		Stop Valve	
		Stop Valve with By-pass	
		Stop Valve with Tapers	
		Closed Stop Valve	
		Air Valve	
		Valve	
		Scour	
		Reducer / Taper	
		Vertical Bends	
		Reservoir	
		Recycled Water is shown as per Potable above. Colour as indicated	
Vacuum Sewer		Private Mains	
Pressure Sewer Main		Potable Water Main	
Division Valve		Recycled Water Main	
Vacuum Chamber		Sewer Main	
Clean Out Point		Symbols for Private Mains shown grey	
Stormwater			
Stormwater Pipe			
Stormwater Channel			
Stormwater Gully			
Stormwater Maintenance Hole			

Disclaimer

The information on this print shows if we provide any water, wastewater or stormwater services to this property. It may not be accurate or to scale. If you'd like to see the location of private wastewater pipes on the property, please buy a **Sewer service diagram**.

Pipe Types

ABS	Acrylonitrile Butadiene Styrene	AC	Asbestos Cement
BRICK	Brick	CI	Cast Iron
CICL	Cast Iron Cement Lined	CONC	Concrete
COPPER	Copper	DI	Ductile Iron
DICL	Ductile Iron Cement (mortar) Lined	DIPL	Ductile Iron Polymeric Lined
EW	Earthenware	FIBG	Fibreglass
FL BAR	Forged Locking Bar	GI	Galvanised Iron
GRP	Glass Reinforced Plastics	HDPE	High Density Polyethylene
MS	Mild Steel	MSCL	Mild Steel Cement Lined
PE	Polyethylene	PC	Polymer Concrete
PP	Polypropylene	PVC	Polyvinylchloride
PVC - M	Polyvinylchloride, Modified	PVC - O	Polyvinylchloride, Oriented
PVC - U	Polyvinylchloride, Unplasticised	RC	Reinforced Concrete
RC-PL	Reinforced Concrete Plastics Lined	S	Steel
SCL	Steel Cement (mortar) Lined	SCL IBL	Steel Cement Lined Internal Bitumen Lined
SGW	Salt Glazed Ware	SPL	Steel Polymeric Lined
SS	Stainless Steel	STONE	Stone
VC	Vitrified Clay	WI	Wrought Iron
WS	Woodstave		

Further Information

Please consult the Dial Before You Dig enquiries page on the Sydney Water website.

For general enquiries please call the Customer Contact Centre on 132 092

In an emergency, or to notify Sydney Water of damage or threats to its structures, call 13 20 90 (24 hours, 7 days)

Disclaimer

The information on this print shows if we provide any water, wastewater or stormwater services to this property. It may not be accurate or to scale. If you'd like to see the location of private wastewater pipes on the property, please buy a **Sewer service diagram**.

Sewer Service Diagram

Application Number: 8002077324

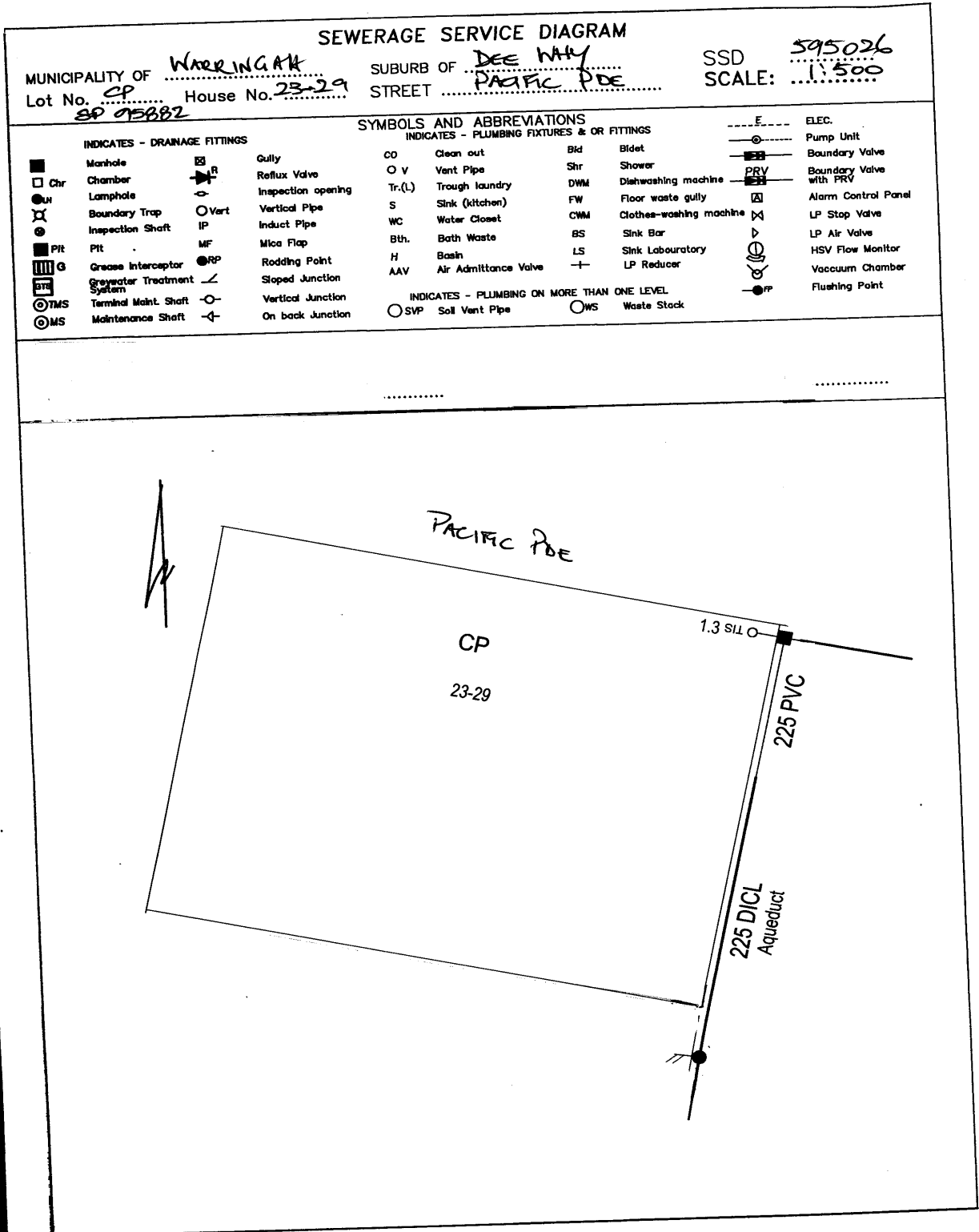

Disclaimer

The information in this diagram shows the private wastewater pipes on this property. It may not be accurate or to scale and may not show our pipes, structures or all property boundaries. If you'd like to see these, please buy a **Service location print**.

Northern Beaches Council Planning Certificate – Part 2

Applicant: Linc At Law
Level 10 Suite 2 60 York Street
SYDNEY NSW 2000

Reference: 220305
Date: 07/11/2022
Certificate No. ePLC2022/07908

Address of Property: GrdFloor 12G/23-29 Pacific Parade DEE WHY NSW 2099
Description of Property: Lot 12 SP 95882

Planning Certificate – Part 2

The following certificate is issued under the provisions of Section 10.7(2) of the *Environmental Planning and Assessment Act 1979* (as amended – formerly Section 149). The information applicable to the land is accurate as at the above date.

1. Relevant planning instruments and Development Control Plans

(1) The name of each environmental planning instrument and development control plan that applies to the carrying out of development on the land:

(a) Local Environmental Plan

Warringah Local Environmental Plan 2011

(b) State Environmental Planning Policies and Regional Environmental Plans

State Environmental Planning Policy (Housing) 2021

State Environmental Planning Policy (Primary Production) 2021
Chapters 1,2

State Environmental Planning Policy (Resources and Energy) 2021
Chapters 1, 2

State Environmental Planning Policy (Resilience and Hazards) 2021
Chapters 1, 3, 4

State Environmental Planning Policy (Industry and Employment) 2021
Chapters 1, 3

State Environmental Planning Policy (Transport and Infrastructure) 2021
Chapters 1, 2, 3

State Environmental Planning Policy (Biodiversity and Conservation) 2021
Chapters 1, 2, 3, 4, 6, 7

State Environmental Planning Policy (Planning Systems) 2021
Chapters 1, 2

State Environmental Planning Policy (Precincts – Eastern Harbour City) 2021
Chapters 1, 2

State Environmental Planning Policy (Exempt and Complying Development Codes) 2008
SEPP 65 – Design Quality of Residential Apartment Development
SEPP (Building Sustainability Index: BASIX)

State Environmental Planning Policy (Biodiversity and Conservation) 2021
Chapters 9, 10

(c) Development Control Plans

Warringah Development Control Plan 2011

(2) Draft Environmental Planning Instruments

The name of each proposed environmental planning instrument and draft development control plan, which is or has been subject to community consultation or public exhibition under the Act, that will apply to the carrying out of development on the land.

(a) Draft Local Environmental Plans

(b) Draft State Environmental Planning Policies

Draft State Environmental Planning Policy (Environment)

Draft Remediation of Land State Environmental Planning Policy (intended to replace State Environmental Planning Policy 55)

(c) Draft Development Control Plans

2. Zoning and land use under relevant planning instruments

The following matters for each environmental planning instrument or draft environmental planning instrument that includes the land in a zone, however described—

(1) Zoning and land use under relevant Local Environmental Plans

(a), (b)

The following information identifies the purposes for which development may be carried out with or without development consent and the purposes for which the carrying out of development is prohibited, for all zones (however described) affecting the land to which the relevant Local Environmental Plan applies.

EXTRACT FROM WARRINGAH LOCAL ENVIRONMENTAL PLAN 2011

Zone R3 Medium Density Residential

1 Objectives of zone

- To provide for the housing needs of the community within a medium density residential environment.

- To provide a variety of housing types within a medium density residential environment.
- To enable other land uses that provide facilities or services to meet the day to day needs of residents.
- To ensure that medium density residential environments are characterised by landscaped settings that are in harmony with the natural environment of Warringah.
- To ensure that medium density residential environments are of a high visual quality in their presentation to public streets and spaces.

2 Permitted without consent

Home-based child care; Home occupations

3 Permitted with consent

Attached dwellings; Bed and breakfast accommodation; Boarding houses; Boat sheds; Building identification signs; Business identification signs; Centre-based child care facilities; Community facilities; Dual occupancies; Dwelling houses; Educational establishments; Emergency services facilities; Environmental protection works; Exhibition homes; Group homes; Home businesses; Multi dwelling housing; Neighbourhood shops; Oyster aquaculture; Places of public worship; Recreation areas; Residential flat buildings; Respite day care centres; Roads; Secondary dwellings; Seniors housing; Tank-based aquaculture; Veterinary hospitals

4 Prohibited

Any other development not specified in item 2 or 3

Employment zones reform implementation

On 1 December 2022, Business and Industrial zones will be replaced by the new Employment zones under the Standard Instrument (Local Environmental Plans) Order 2006. The Department of Planning and Environment is currently exhibiting details of how each Local Environmental Plan that includes a current Business or Industrial zone will be amended to use the new Employment zones. The Explanation of Intended Effect (EIE) and a searchable web tool that displays the current and proposed zone for land covered in this public exhibition is available on the [Planning Portal](#).

(c) Additional permitted uses

Additional permitted uses, if any, for which development is permissible with development consent pursuant to Clause 2.5 and Schedule 1 of the relevant Local Environmental Plan:

Nil

(d) Minimum land dimensions

The *Warringah Local Environmental Plan 2011* contains no development standard that fixes minimum land dimensions for the erection of a dwelling house on the land.

(e) Outstanding biodiversity value

The land is not in an area of outstanding biodiversity value under the [Biodiversity Conservation Act 2016](#)

(f) Conservation areas

The land is not in a heritage conservation area.

(g) Item of environmental heritage

The land does not contain an item of environmental heritage.

(2) Zoning and land use under draft Local Environmental Plans

For any proposed changes to zoning and land use, see Part 1.2 (a)

Please contact Council's Strategic and Place Planning unit with enquiries on 1300 434 434.

3. Contribution plans

(1) The name of each contributions plan under the Act, Division 7.1 applying to the land, including draft contributions plans.

Northern Beaches Section 7.12 Contributions Plan 2022 - in force 1 June 2022.

(2) If the land is in a special contributions area under the Act, Division 7.1, the name of the area.

Nil

4. Complying Development

If the land is land on which complying development may or may not be carried out under each of the complying development codes under [State Environmental Planning Policy \(Exempt and Complying Development Codes\) 2008](#), because of that Policy, clause 1.17A(1)(c)–(e), (2), (3) or (4), 1.18(1)(c3) or 1.19.

Part 3 Housing Code

Complying Development under the Housing Code may be carried out on all of the land.

Part 3A Rural Housing Code

Complying Development under the Rural Housing Code may be carried out on all of the land.

Part 3B Low Rise Housing Diversity Code

Complying Development under the Low Rise Housing Diversity Code may be carried out on all of the land.

Part 3C Greenfield Housing Code

Complying Development under the Greenfield Housing Code may not be carried out on all of the land.

Part 3D Inland Code

Complying Development under the Inland Code does not apply to the land.

Note: Pursuant to clause 3D.1 of the *State Environmental Planning Policy (Exempt and Complying Development Codes) 2008*, the Inland Code only applies to 'inland local government areas'. Northern Beaches local government area is not defined as an 'inland local government area' by *State Environmental Planning Policy (Exempt and Complying Development Codes) 2008*.

Part 4 Housing Alterations Code

Complying Development under the Housing Alterations Code may be carried out on all of the land.

Part 4A General Development Code

Complying Development under the General Development Code may be carried out on all of the land.

Part 5 Industrial and Business Alterations Code

Complying Development under the Industrial and Business Alterations Code may be carried out on all of the land.

Part 5A Industrial and Business Buildings Code

Complying Development under the Industrial and Business Buildings Code may be carried out on all of the land.

Part 5B Container Recycling Facilities Code

Complying Development under the Container Recycling Facilities Code may be carried out on all of the land.

Part 6 Subdivisions Code

Complying Development under the Subdivisions Code may be carried out on all of the land.

Part 7 Demolition Code

Complying Development under the Demolition Code may be carried out on all of the land.

Part 8 Fire Safety Code

Complying Development under the Fire Safety Code may be carried out on all of the land.

(4) Complying Development Codes varied under Clause 1.12 of the *State Environmental Planning Policy (Exempt and Complying Development Codes) 2008*

No complying codes are varied under this clause in relation to the land.

5. Exempt Development

If the land is land on which exempt development may or may not be carried out under each of the exempt development codes under [State Environmental Planning Policy \(Exempt and Complying Development Codes\) 2008](#), because of that Policy, clause 1.16(1)(b1)–(d) or 1.16A.

Part 2 Exempt Development Codes

Exempt Development under the Exempt Development Codes may be carried out on all of the land.

(4) Exempt Development Codes varied under Clause 1.12 of the *State Environmental Planning Policy (Exempt and Complying Development Codes) 2008*

No exempt development codes are varied under this clause in relation to the land.

6. Affected building notices and building product rectification orders

- (a) There is not an affected building notice of which the council is aware that is in force in respect of the land.
- (b) There is not a building product rectification order of which the council is aware that is in force in respect of the land and has not been fully complied with, and
- (c) There is not a notice of intention to make a building product rectification order of which the council is aware has been given in respect of the land and is outstanding.

In this section—

affected building notice has the same meaning the *Building Products (Safety) Act 2017, Part 4*.

building product rectification order has the same meaning as in the *Building Products (Safety) Act 2017*.

7. Land reserved for acquisition

Environmental planning instrument referred to in Clause 1 does not make provision in relation to the acquisition of the land by a public authority, as referred to in section 3.15 of the Act.

8. Road widening and road realignment

- (a) The land is not affected by a road widening or re-alignment proposal under Division 2 of Part 3 of the *Roads Act 1993*.
- (b) The land is not affected by a road widening or re-alignment proposal under an environmental planning instrument.
- (c) The land is not affected by a road widening or re-alignment proposal under a resolution of Council.

9. Flood related development controls

- (1) The land is within the flood planning area and subject to flood related development controls.
- (2) The land or part of the land is between the flood planning area and the probable maximum flood and subject to flood related development controls.

In this section—

flood planning area has the same meaning as in the Floodplain Development Manual.

Floodplain Development Manual means the Floodplain Development Manual (ISBN 0 7347 5476 0) published by the NSW Government in April 2005.

probable maximum flood has the same meaning as in the Floodplain Development Manual.

10. Council and other public authority policies on hazard risk restriction

- (a) Council has adopted policies that restrict the development of the land because of the likelihood of land slip, bush fire, tidal inundation, subsidence, acid sulfate soils, contamination, aircraft noise,

salinity, coastal hazards, sea level rise or another risk, other than flooding (for flooding – see 9). The identified hazard or risk, if any, are listed below:

Nil

(b) The following information applies to any policy as adopted by any other public authority and notified to the Council for the express purpose of its adoption by that authority being referred to in a planning certificate issued by the Council. The identified hazard or risk and the respective Policy which affect the property, if any, are listed below:

Nil

11. Bush fire prone land

The land is not bush fire prone land.

12. Loose-fill asbestos insulation

The residential dwelling erected on this land has not been identified in the Loose-Fill Asbestos Insulation Register as containing loose-fill asbestos ceiling insulation.

This clause applies to residential premises (within the meaning of Division 1A of part 8 of the Home Building Act 1989) that are listed in the register that is required to be maintained under that Division.

Contact NSW Fair Trading for more information.

13. Mine Subsidence

The land is not declared to be a mine Subsidence (Mine Subsidence) district within the meaning of section 15 of the *Mine Subsidence (Mine Subsidence) Compensation Act, 1961*.

14. Paper subdivision information

There is no current paper subdivision, of which council is aware, in respect of this land according to Part 10 of the *Environmental Planning and Assessment Regulation 2021* and Schedule 7 of the *Environmental Planning & Assessment Act 1997 No 203*.

15. Property vegetation plans

The Council has not been notified that the land is land to which a vegetation plan under the *Native Vegetation Act 2003* applies.

16. Biodiversity Stewardship Sites

The Council has not been notified by the Biodiversity Conservation Trust that the land is a biodiversity stewardship site under a biodiversity stewardship agreement under Part 5 of the *Biodiversity Conservation Act 2016* (includes land to which a biobanking agreement under Part 7A of the repealed *Threatened Species Conservation Act 1995* relates).

17. Biodiversity certified land

The land is not biodiversity certified land under Part 8 of the *Biodiversity Conservation Act 2016* (includes land certified under Part 7AA of the repealed *Threatened Species Conservation Act 1995*).

18. Orders under Trees (Disputes Between Neighbours) Act 2006

Council has not been notified of the existence of an order made under the *Trees (Disputes Between Neighbours) Act 2006* to carry out work in relation to a tree on the land.

19. Annual charges under Local Government Act 1993 for coastal protection services that relate to existing coastal protection works

The owner of the land (or any previous owner) has not consented in writing to the land being subject to annual charges under section 496B of the *Local Government Act 1993* for coastal protection services that relate to existing coastal protection works (within the meaning of section 553B of that Act).

Note—

Existing coastal protection works are works to reduce the impact of coastal hazards on land, such as seawalls, revetments, groynes and beach nourishment, that existed before 1 January 2011.

20. Western Sydney Aerotropolis

Under State Environmental Planning Policy (Precincts – Western Parkland City) 2021, Chapter 4 the land is –

- (a) not in an ANEF or ANEC contour of 20 or greater, as referred to in that Chapter, section 4.17, or
- (b) not shown on the [Lighting Intensity and Wind Shear Map](#), or
- (c) not shown on the [Obstacle Limitation Surface Map](#), or
- (d) not in the “public safety area” on the [Public Safety Area Map](#), or
- (e) not in the “3 kilometre wildlife buffer zone” or the “13 kilometre wildlife buffer zone” on the [Wildlife Buffer Zone Map](#).

21. Development consent conditions for seniors housing

No condition of development consent granted after 11 October 2007 in relation to the land applies to the property that are of the kind set out in that Policy, section 88(2) of [State Environmental Planning Policy \(Housing\) 2021](#).

22. Site compatibility certificate and conditions for affordable rental housing

- (1) There is not a current site compatibility certificate of which the council is aware, in respect of proposed development on the land.

(2) No condition of development consent in relation to the land applies to the property that are of the kind set out in section 21(1) or 40(1) of [State Environmental Planning Policy \(Housing\) 2021](#).

(3) No condition of development consent in relation to the land applies to the property that are of the kind set out in clause 17(1) or 38(1) of [State Environmental Planning Policy \(Affordable Rental Housing\) 2009](#).

Additional matters under the Contaminated Land Management Act 1997

Note. The following matters are prescribed by section 59 (2) of the *Contaminated Land Management Act 1997* as additional matters to be specified in a planning certificate:

- (a) the land to which the certificate relates is not significantly contaminated land within the meaning of that Act
- (b) the land to which the certificate relates is not subject to a management order within the meaning of that Act
- (c) the land to which the certificate relates is not the subject of an approved voluntary management proposal within the meaning of that Act
- (d) the land to which the certificate relates is not subject to an ongoing maintenance order within the meaning of that Act
- (e) the land to which the certificate relates is not the subject of a site audit statement

If contamination is identified above please contact the Environmental Protection Authority (EPA) for further information.



**Ray Brownlee PSM
Chief Executive Officer**

07/11/2022